

Courtship and Mating Behavior

*Lynne D. Houck
and Stevan J. Arnold*

10.1 OVERVIEW OF COURTSHIP AND MATING BEHAVIOR

A comprehensive review of courtship behavior in salamanders was last presented by Salthe (1967). Many new behavioral observations have been made in the ensuing 35 years. Below, we summarize trends in courtship behavior within and among salamander families. We also consider the nature of major evolutionary transitions in courtship behavior.

Before reviewing the courtship behaviors for each salamander family, we first consider basic differences that transcend family boundaries. Certainly the most basic difference in mating behavior among urodeles is that some species have external fertilization while other species (the majority) exhibit internal fertilization. Internal fertilization is a two-step process. First, the male inseminates the female. Salamanders do not possess an intromittent organ, so insemination is accomplished by sperm transfer via a spermatophore (described below). Once insemination has occurred, the second step in the process of internal fertilization is to unite the sperm with the ova. Fertilization can be delayed, however, as females having internal fertilization possess a sperm storage organ, termed a spermatheca (Sever 2000, and Chapter 9 in this volume). The significance of coupling the female's ability to store sperm with internal fertilization is that fertilization need not occur shortly after insemination, or even during the mating season. In fact, fertilization and oviposition can occur many months after the mating season is over (Sever 2000). In species that decouple insemination and fertilization, the timing of oviposition and the location of the oviposition site are determined by the female. Consequently, parental care also is decoupled from courtship and mating and, in species having internal fertilization, the female typically cares for the developing ova.

Another basic difference among urodele species is that the site where courtship and mating occur can be completely aquatic, either aquatic or terrestrial, or restricted only to sites that are terrestrial. Earlier hypotheses about the evolution of courtship behavior in salamanders predicted that the ecological site where mating occurred was of paramount importance in influencing behavioral adaptations (Salthe 1967). In contrast, our survey below shows that ecological sites are poor predictors of salamander courtship behavior. Instead, the significance of the mating site is that it may affect the nature of male-male competition or the ability of the female to select a mate (e.g., Sullivan *et al.* 1995). These important topics, however, are not the focus of the current chapter. Below, we address questions that apply more specifically to modes of courtship.

We focus on an evolutionary overview of courtship and mating behavior for each of the urodele families. Several major questions are considered: (1) How many times did internal fertilization evolve in urodeles? (2) What were the ancestral mode(s) of internal fertilization? (3) How were major transitions in courtship accomplished? and (4) What is the ancestral mode of courtship in each family? Urodele courtship presents many phylogenetic quandaries in which it is difficult to conceive how behavioral transitions were accomplished. We attempt to elucidate some of the problematic transitions, but merely highlight others for future analysis.

Before beginning our review of courtship and mating behavior in urodele families, we first cover a few methodological points. Statements in the following accounts without attribution refer to our own observations. We have observed courtship in the following families and genera: Plethodontidae (*Desmognathus*, *Pseudotriton*, *Eurycea*, *Hemidactylum*, *Bolitoglossa*, *Dendrotriton*, *Batrachoseps*, *Plethodon*, *Ensatina*, *Aneides*); Salamandridae (*Pleurodeles*, *Salamandrina*, *Salamandra*, *Euproctus*, *Chioglossa*, *Taricha*, *Notophthalmus*, *Cynops*, *Paramesotriton*, *Triturus*), Ambystomatidae (*Ambystoma*), and Rhyacotritonidae (*Rhyacotriton*). Figures are taken from 35 mm still photographs and 16 mm movie film. Accounts for the above and other genera also are based on descriptions in the literature, especially those accounts illustrated with photographs or drawings. For evolutionary analyses, we used the phylogenetic trees presented by Larson *et al.* (Chapter 2, this volume). That chapter also may be consulted for descriptions of morphology and ecology. In reconstructing character evolution on those trees, we minimized the number of evolutionary steps. We also assumed that character loss was more probable than character origin.

For each salamander family, we describe below the main mode(s) of courtship behavior. We also describe the nature of variation in particular aspects of courtship (for example, types of amplexus in salamandrids). Finally, we infer the ancestral courtship behavior for each family for which there is sufficient information.

10.2 COURTSHIP IN URODELE FAMILIES WITH INTERNAL FERTILIZATION

Courtship is best described for species of plethodontids and salamandrids, so we begin the description of courtship and mating behavior with these two families. Plethodontid species are considered first because their courtship is more highly stereotyped and exhibits less diversity.

10.2.1 Courtship in the Plethodontidae

Courtship in this family is remarkable for its uniformity. In all plethodontid species for which mating behavior has been observed, the following sequence (Fig. 10.1) is typical: (A) the male orients to and approaches the female; (B) the male initiates head contact with the female; (C) the pair engage in a tail-straddling walk in which the female has her chin on the male's tail base while she straddles the male's tail; (D) spermatophore deposition occurs in front of the female's snout; and (E) usually only one or a few spermatophores are deposited per courtship (Arnold 1977). Sperm transfer occurs when the female moves forward and then lowers her cloaca over the spermatophore. She lodges the sperm mass in her cloaca before she lifts off, leaving the base of the spermatophore on the substrate.

Courtship pheromones. The typical courtship sequence described above usually is accompanied by the delivery of male courtship pheromones during the tail-straddling walk. In particular, delivery of male courtship pheromones occurs when the female is not already highly receptive. These courtship pheromones are chemical signals that increase the level of female receptivity (Arnold and Houck 1982; Houck 1986; Houck *et al.* 1998). Pheromone delivery is not an absolute requirement for a successful courtship, but pairs in which the male experimentally lacks a pheromone gland take longer to complete the courtship (Houck and Reagan 1990; Rollmann *et al.* 1999).

The pheromone delivery system of plethodontid salamanders presents a remarkable picture of behavioral and morphological stability (Houck and Sever 1994). Species in each of the four major lineages (both subfamilies and in all three tribes of plethodontines) share the same, complex system of pheromone delivery by "vaccination." During the courtship season, the male grows hypertrophied premaxillary teeth and develops a small pad of glandular tissue (the mental gland) on his chin. During courtship, the male abrades the female's skin with his premaxillary teeth and rubs secretions from his mental gland into the abraded site. These secretions increase female receptivity and shorten the time to sperm transfer (Houck and Reagan 1990; Rollmann *et al.* 1999). As this complex system is found in all four major lineages of plethodontids and in no other salamander family, vaccination delivery was undoubtedly present in the ancestral plethodontid. Thus, because the family itself is approximately 100 million years old (Ruben *et al.* 1993), the morphological and behavioral elements in the delivery system have been conserved over that entire period.



Fig. 10.1 Tail-straddling walk and sperm transfer in *Plethodon shermani*. **A.** Male (right) and female (left) in tail-straddling walk. **B.** The male turning back to the female in tail-straddling walk, preparing to slap his mental gland (visible on his chin) on the female's snout.

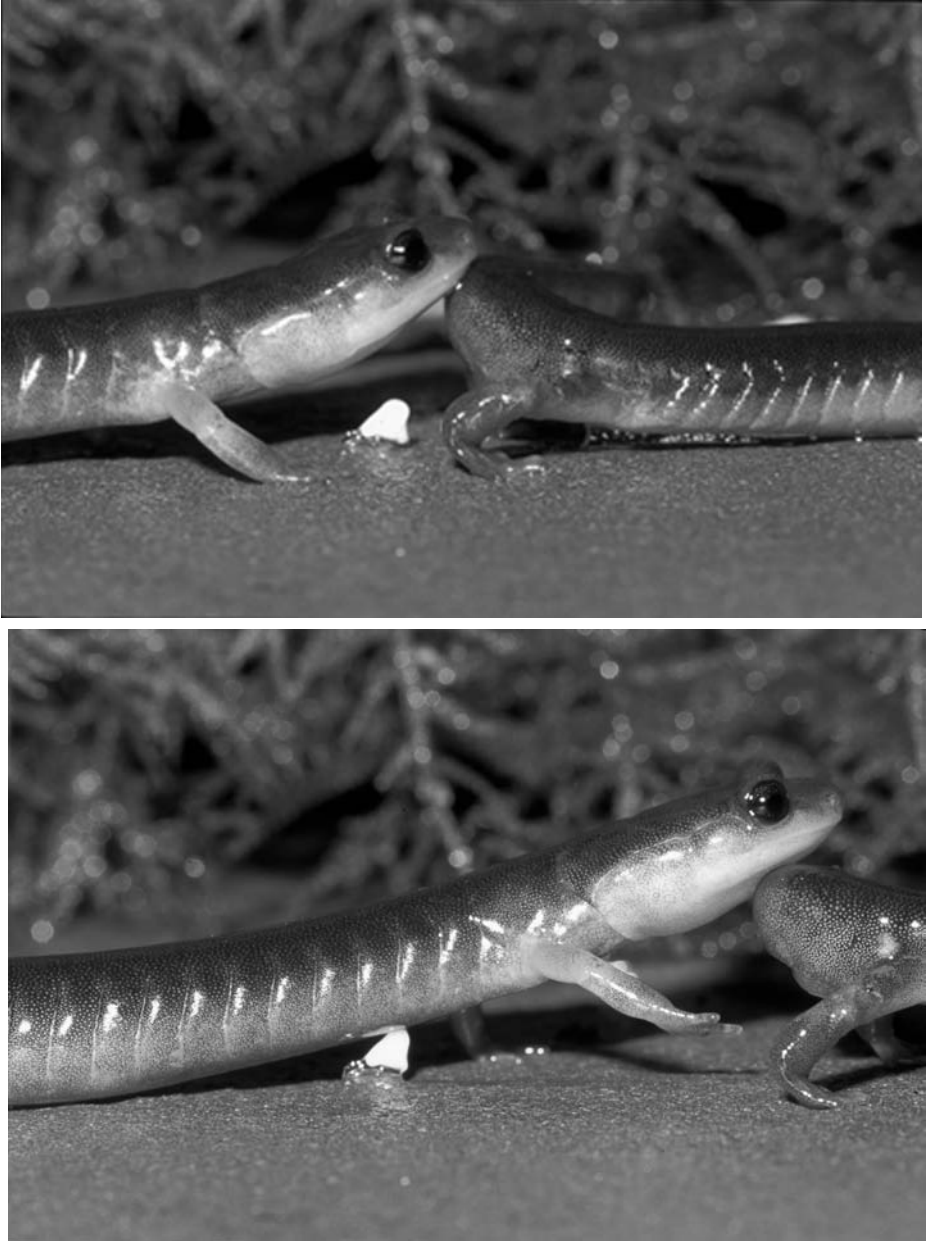

Fig. 10.1 Tail-straddling walk and sperm transfer in *Plethodon shermani*. **C.** The male lifting off of a recently deposited spermatophore (the sperm cap is white) and beginning to lead the female over it. **D.** The female, following the male, moving over the spermatophore.



Fig. 10.1 Tail-straddling walk and sperm transfer in *Plethodon shermani*. **E.** The female has stopped over the spermatophore and is lowering her cloaca over it. **F.** The male (right) lifting his tail base under the female's chin as she removes the sperm cap from the spermatophore. Animals from Macon Co., North Carolina.

An equally puzzling example of conserved courtship traits is found within the genus *Plethodon*. In this genus, the approximately 40 species found in eastern North America form a monophyletic group. This group has two subdivisions of species that differ greatly in body size: the small eastern *Plethodon* and the large eastern *Plethodon* (Highton and Larson 1979; Larson *et al.* 1981; Highton and Peabody 2000; Larson *et al.*, Chapter 2 of this volume). The small eastern *Plethodon* (approximately 12 species) retain the ancestral mode of vaccination delivery of pheromones. The large eastern species (approximately 29 species) are a monophyletic group that share an olfactory mode of pheromone delivery. In these species, the males lack protruding premaxillary teeth and possess a large circular mental gland (described in Houck and Sever 1994). These species deliver pheromones by slapping their large mental glands over the female's snout during courtship (see Fig 10.1B). Immunological and allozyme data indicate that the radiation of large eastern *Plethodon*—and hence the olfactory mode of delivery—is about 15 million years old (Highton and Larson 1979). Although we do not understand the details of the process that is responsible for this second example of conserved courtship behavior, under the same argument as before, this conservation is probably a consequence of stabilizing selection maintained over a 15 million year period.

Loss of pheromone delivery is a recurrent theme in plethodontids (Houck and Sever 1994). In some species, males have secondarily lost mental glands, and also lack the behaviors associated with courtship pheromone delivery (e.g., *Ensatina*, Stebbins 1949). Even in species that deliver courtship pheromones, delivery can be facultative (Arnold 1976). This facultative pheromone delivery may provide a clue as to how delivery is lost completely.

Evolutionary themes: courtship duration, courtship differences among congeneric species, and biting during courtship. Courtship durations are lengthy in plethodontids, particularly when compared with durations observed for salamanders in other families. In some plethodontids, tail-straddling walk can last several hours (Stebbins 1949; Sapp 2002). This relatively long duration of courtship prior to spermatophore deposition could be necessitated in part by the physiological coordination of the male and female. In addition, courtship success depends upon the female being sufficiently motivated to stay with the male during the 3-7 min that it takes to form and deposit a spermatophore. Although courtships are not energetically expensive (Marks and Houck 1989; Bennett and Houck 1983), the lengthy duration of plethodontid courtships may be costly by increasing the probability of interruptions from rival males or from predators (Houck and Reagan 1990). One advantage of a lengthy courtship, however, is that the probability of a courting female becoming inseminated is much higher than for other taxa having more abbreviated courtship interactions (Arnold 1977).

Other evolutionary themes are illustrated by detailed studies of behavioral variation among many species within two plethodontid genera: *Plethodon* (e.g., Arnold 1972, 1977; Marvin and Hutchison 1996) and *Desmognathus* (e.g., Houck and Verrell 1993; Maksymovitch and Verrell 1992; Verrell 1994a,

1994b, 1995, 1997, 1999). Among *Plethodon* species, variation in courtship behavior is largely characterized by the loss or innovation of particular behaviors (Marvin and Hutchison 1996). Among *Desmognathus* species, individual courtship behaviors typically are common across most species, and variation is found in the duration or in the sequence of when behaviors are displayed (Verrell and Mabry 2000; Mead and Verrell 2002). Of note here is that variable behaviors in *Plethodon* and *Desmognathus* are those that occur early in courtship, prior to sperm transfer. In both genera, the sperm transfer stage of courtship is highly stereotyped.

A significantly different courtship behavior is found for two species in the genus *Desmognathus*. In both *D. wrighti* and *D. aeneus*, the male holds the female firmly in his jaws (described as biting) at the beginning of courtship (Houck 1980; Promislow 1987). This behavior presumably allows the male to monopolize the female, and also can serve as part of the persuasion stage of courtship. In *D. wrighti*, for example, mental gland secretions are released near the base of the male's mandibular teeth, where these courtship pheromones apparently find their way into the female's circulatory system (Houck and Sever 1994). Pheromone delivery in *D. aeneus* is more typical of *Desmognathus* species in that pheromone secretion is external, at the skin surface. Phylogenetic information provided by Larson *et al.* (chapter 2, this volume) show that *D. wrighti* and *D. aeneus* are not sister taxa, and thus biting has evolved twice in this genus.

Ancestral courtship. Courtship in the ancestral plethodontid consisted of: (1) approach, followed by head contact, tail-straddling walk, sperm transfer; (2) scratching delivery of pheromones from the male's mental gland using protruding premaxillary teeth (Houck and Sever 1994); (3) spermatophore deposition in front of the female's snout while facing away from the female; and (4) pelvic lifting by the male under the female's chin during spermatophore pickup (Fig. 10.1F).

10.2.2 Courtship in the Salamandridae

Salamandrid courtship is characterized by remarkable diversity among genera in the forms of amplexus and modes of sperm transfer. One mode of courtship consists of male pursuit of the female and amplexus by the male, followed by a sperm transfer attempt. Alternatively, male pursuit may segue directly into sperm transfer attempts without any form of amplexus (*e.g.*, *Triturus*). In courtships lacking amplexus, the male may display in front of the female, and then engage the female in a tail-nudging walk (the female nudges the male's tail) before depositing the spermatophore in front of her snout. The display in front of the female has both visual (Himstedt 1979) and chemical stimuli, with the release of courtship pheromones as the major chemical stimulus (Halliday 1975, 1976). Usually, only a few spermatophores are deposited during a single courtship.

Types of amplexus. A major theme in salamandrid evolution is the innovation

in types of amplexus (Table 10.1). Major types of amplexus and restraint include:

- (1) Ventral amplexus (VA): in which the male holds the female on his back by wrapping both of his forelimbs around her forelimbs (*Tylototriton*, *Pleurodeles*, *Salamandra*, *Chioglossa*, *Mertensiella*).
- (2) Head-to-head amplexus: The male faces the female head-to-head (HTH) with one of his forelimbs wrapped around the ipsilateral forelimb of the female (*Pleurodeles*) (Fig. 10.2). A variant of the head-to-head position is found in *Salamandrina* (Fig. 10.3A) and *Tylototriton*: the pair face head-to-head and circle, but without the forelimbs interlocked.
- (3) Dorsal amplexus (DA): in which the male is situated on the female's back: (A) while his forelimbs grasp the female's pectoral region (*Salamandra*, *Taricha*) (Fig. 10.4), or (B) while his hind limbs grasp the female's pectoral region (*Notophthalmus*) (Fig. 10.5).
- (4) Restraint of the female (FR) using the tail, hind limbs and jaws (*Euproctus*) (Fig. 10.6).
- (5) Complete absence of amplexus (NA) (*Triturus*, *Cynops*, *Paramesotriton*, *Neureergus*, *Pachytriton*). Also in this category is *Notophthalmus*, because some courtships bypass amplexus and proceed directly to sperm transfer (Arnold 1972; Verrell 1982).

Table 10.1 Modes of amplexus in the salamandrid genera. VA = ventral amplexus, HTH = head-to-head amplexus, DA = dorsal amplexus, FR = female is completely restrained, NA = no amplexus. See Fig. 10.7 for evolution of these modes of amplexus. References are listed below. 1 = trait present; 0 = trait absent.

| Taxon | ref | VA | HTH | DA | FR | NA |
|-----------------------|-----|----|-----|----|----|----|
| <i>Tylototriton</i> | 1 | 1 | 1 | 0 | 0 | 0 |
| <i>Salamandrina</i> | 2 | 0 | 1 | 0 | 0 | 0 |
| <i>Pleurodeles</i> | 3 | 1 | 1 | 0 | 0 | 0 |
| <i>Salamandra</i> | 4 | 1 | 0 | 1 | 0 | 0 |
| <i>Mertensiella</i> | 5 | 1 | 0 | 0 | 0 | 0 |
| <i>Chioglossa</i> | 6 | 1 | 0 | 0 | 0 | 0 |
| <i>Taricha</i> | 7 | 0 | 0 | 1 | 0 | 0 |
| <i>Notophthalmus</i> | 8 | 0 | 0 | 1 | 0 | 1 |
| <i>Triturus</i> | 9 | 0 | 0 | 0 | 0 | 1 |
| <i>Neureergus</i> | 10 | 0 | 0 | 0 | 0 | 1 |
| <i>Pachytriton</i> | 11 | 0 | 0 | 0 | 0 | 1 |
| <i>Cynops</i> | 12 | 0 | 0 | 0 | 0 | 1 |
| <i>Paramesotriton</i> | 13 | 0 | 0 | 0 | 0 | 1 |
| <i>Euproctus</i> | 14 | 0 | 0 | 0 | 1 | 0 |

(1) Rehberg 1986; Fleck 1992; Dasgupta 1994; (2) SA, personal observations; (3) Bedriaga 1882a; Gallien 1953; Arnold 1972, 1977; (4) Joly 1966; Arnold 1987; (5) Obst and Rotter 1962; (6) Thorn 1966b, Arnold 1987; (7) Davis and Twitty 1964; (8) Arnold 1972, Verrell 1982; (9) Arntzen and Sparreboom 1989; Halliday 1990; (10) Sparreboom *et al.* 2000; (11) Thiesmeier and Hornberg 1997; (12) Sawada 1963; Arnold 1972; Sparreboom 1997; (13) Sparreboom 1986; (14) Bedriaga 1882b; 1883; Despax 1923; Ahrenfeldt 1955; Guillaume 1999; SA, personal observations.

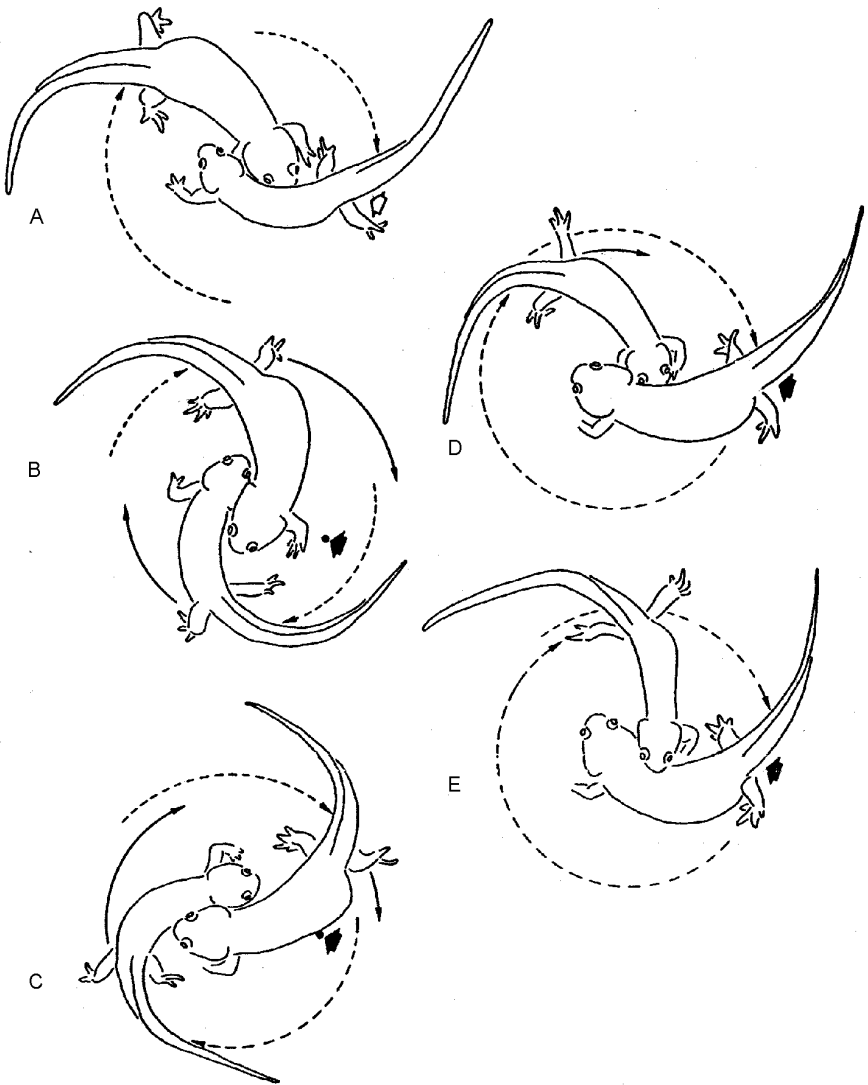

Fig. 10.2 Pin-wheel sperm transfer in *Pleurodeles waltl*. From a series of photographs after Arnold, S.J. 1972. Ph.D. thesis, University of Michigan, Ann Arbor, Michigan, Fig. 65. **A.** After rotating clockwise, the pair has stopped and the male (smaller animal) is depositing a spermatophore (open arrow). The male's right forelimb is wrapped around the female's right forelimb. **B.** The male pivots about his right forelimb, swinging his cloaca in an arc, away from the spermatophore (solid arrow). **C.** As the female continues to pivot, the spermatophore contacts her abdomen. **D.** The female stops with her cloaca over the spermatophore, as the male continues to pivot. Note that the male and female have exactly reversed positions (compare with A). **E.** The male has stopped and nudges the female as she remains over the spermatophore. Animals are laboratory stock maintained at Wayne State University.

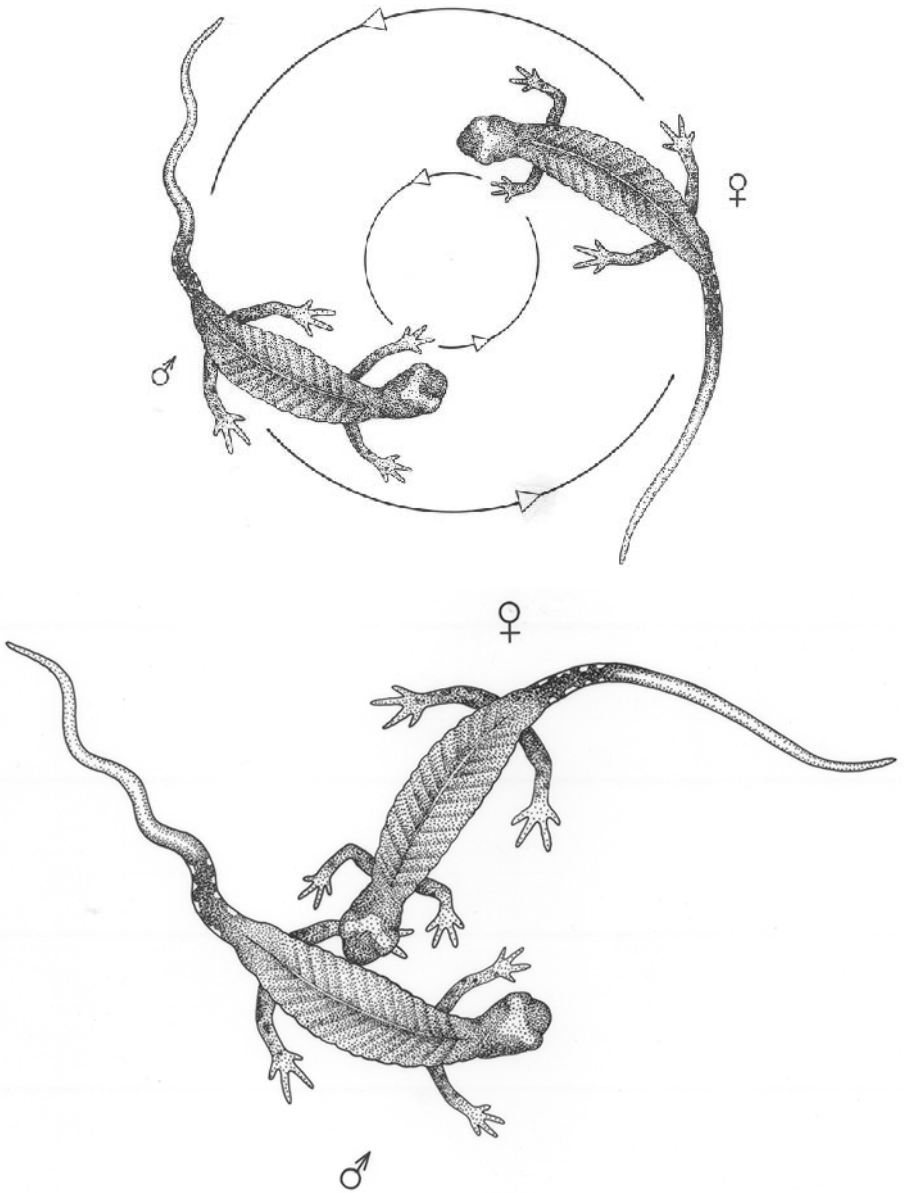

Fig. 10.3 Head-to-head posture during pin-wheel sperm transfer in *Salamandrina terdigitata* (from sketches made by S. Arnold and L. Houck in the field). **A.** The male and female face head-to-head and circle one another in pin-wheel fashion during sperm transfer. The outer circle shows the path of the pair's cloacae; the inner circle shows the path of their ipsilateral forefeet. **B.** When the male stops to deposit a spermatophore, the female continues to circle and then stops in the illustrated position, nudging the male's flank. Animals are from near Cardoso, Italy. Drawings by T. R. Halliday.

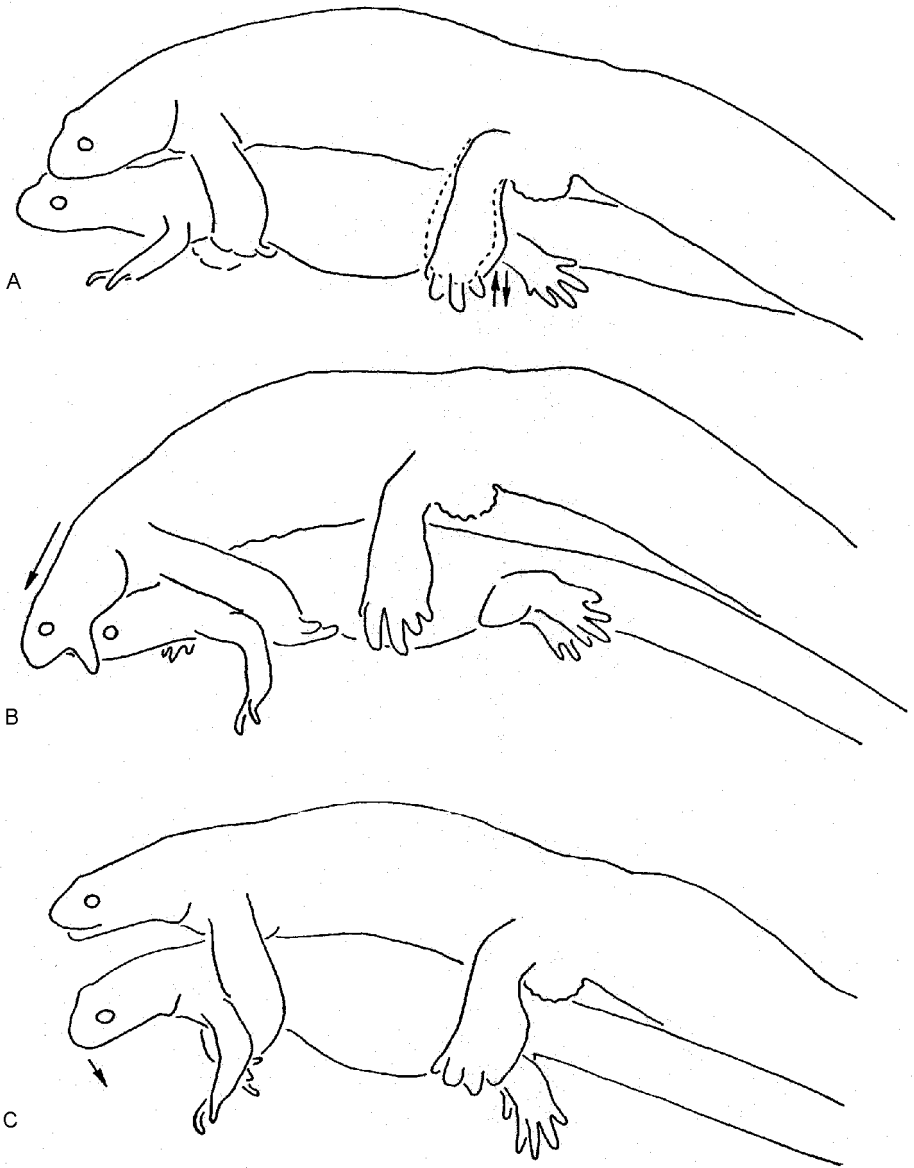

Fig. 10.4 Courtship behaviors during dorsal amplexus in *Taricha granulosa*. From a 16 mm movie, total elapsed time 2.1 sec, after Arnold, S.J. 1972. Ph.D. thesis, University of Michigan, Ann Arbor, Michigan, Fig. 40. **A.** The male (above) performs jerking movements of his hind limbs during dorsal amplexus (0 sec). **B.** The male shifts forward and presses his submandibular gland on the female's snout by opening his mouth (1.1 sec). **C.** The male shifts back to his former position (2.1 sec). Animals are from Benton Co., Oregon.



Fig. 10.5 Courtship behaviors during dorsal amplexus in *Notophthalmus viride-scens*. From a 16 mm move, total elapsed time 13.6 sec, after Arnold, S.J. 1972. Ph.D. thesis, University of Michigan, Ann Arbor, Michigan, Fig. 45. **A.** The male (above) rubs his forearm across the female's snout (0 sec). **B.** The male presses the genial glands on his cheek against the female's snout as he lifts his forelimb under her chin (4.2 sec). **C.** The male tail-fans while continuing to presses his cheek against the female's snout (5.7 sec). **D.** The male rapidly and repeatedly jerks his tail base as he rubs his genial glands on the female's snout (8.4-10.4 sec). **E.** The male rapidly thrashes his body from side to side (11.3-11.4 sec). **F.** The male tail-fans while pressing his left cheek against the female's snout, completing a cycle of behaviors (compare with **C**). Animals are from Washtenaw Co., Michigan.



Fig. 10.6 Physical restraint of a female (right) by a male (left) *Euproctus montanus*. Animals are from near Porto Vecchio, Corsica.

The probable phylogenetic history of amplexus in salamandrids is reconstructed in Fig. 10.7. Dorsal amplexus has evolved twice in salamandrids: once in *Salamandra* and once in the *Taricha-Notophthalmus* clade. Transitions in the type of amplexus may have been accomplished by switching from unimodal to bimodal amplexus and then losing the original type of amplexus. Thus, two kinds of amplexus are found in each of three genera (*Pleurodeles*, *Tylototriton*, *Notophthalmus*). These genera provide models for bimodal amplexus. In *Pleurodeles* and *Tylototriton*, the male begins with ventral amplexus and rotates out from under the female and engages her in head-to-head amplexus. If preliminary ventral amplexus is deleted in evolutionary time, one obtains

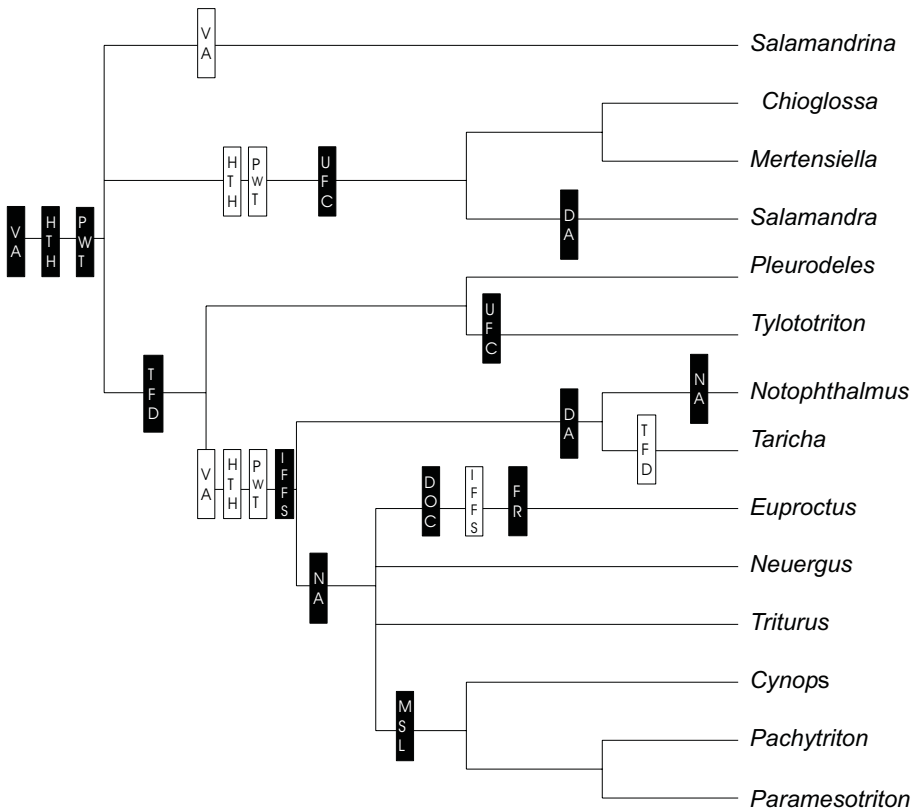

Fig. 10.7 Evolution of courtship characters in salamandrids. Character origins are shown with solid boxes; losses are shown with open boxes. VA = ventral amplexus, HTH = head-to-head amplexus, DA = dorsal amplexus, FR = female is completely restrained, NA = no amplexus, TFD = tail-fanning display, PWT = pin-wheel transfer, IFFS = spermatophore deposited in front of the female's snout, UFC = spermatophore deposited directly under female's cloaca, DOC = spermatophore deposited directly on the female's cloaca, MSL = male and female march forward in a straight line. See Tables 10.1 and 10.2 for distributions of characters among taxa. Cladogram from Larson *et al.* (Chapter 2, this volume).

the head-to-head mode found in *Salamandrina*. Taking another example, the *Taricha-Notophthalmus* ancestor apparently used dorsal amplexus as an obligatory precursor to sperm transfer, as in contemporary *Taricha*. *Notophthalmus* has a bimodal courtship. If the female actively approaches the male, he deletes dorsal amplexus and goes directly to spermatophore deposition. Deletion of preliminary dorsal amplexus during evolution would yield a courtship very much like that found in the clade of Asiatic and European newts. Although *Notophthalmus* is not a part of that clade, the bimodal courtship exhibited by *Notophthalmus* provides a model for the evolutionary origin of courtship without amplexus.

Modes of sperm transfer. Corresponding to the variety in types of amplexus is the remarkable diversity in modes of sperm transfer (Table 10.2, Fig. 10.14). We recognize five modes of sperm transfer in salamandrids:

- (1) The apparent ancestral mode is to deposit the spermatophore two body lengths in front of the female, while facing her head-to-head. The male and female then pivot about ipsilateral forelimbs, rotating pin-wheel (PWT) fashion, so that the female contacts the spermatophore (*Salamandrina*, *Pleurodeles*, *Tylototriton*) (Figs. 10.2, 10.3).
- (2) A derived mode of transfer is to deposit the spermatophore directly under the female's cloaca (UFC) while holding her in ventral amplexus. The male then swings his pelvis 90 degrees to one side, so that the female drops down onto the spermatophore (*Tylototriton*, *Salamandra*, *Chioglossa*, *Mertensiella*). In two genera (*Salamandra* and *Mertensiella*), males have evolved a special protuberance on the tail base. This caudal protuberance is inserted into the female's cloaca during spermatophore deposition, thereby aligning the cloacae of the male and female for sperm transfer.
- (3) Another derived mode of transfer is for the male to deposit the spermatophore in front of the female's snout (IFFS), and then pivot 90 degrees about one forelimb so that the female's path is blocked when she is one body length in front of the spermatophore (*Neurergus*, *Triturus*, *Taricha*, *Notophthalmus*) (Fig. 10.8, 10.9). The female then walks forward over the spermatophore and retrieves sperm.
- (4) The IFFS mode is simplified in several genera in which males do not pivot 90 degrees after each spermatophore deposition, but instead march forward in a straight line (MSL) while the female executes a tail-nudging walk (*Cynops*, *Pachytriton*, *Paramesotriton*) (Fig. 10.10).
- (5) Finally, in the most derived mode, the spermatophore is deposited directly on or near the female's cloaca (DOC), and is massaged into the female's cloaca by the male's hind feet (*Euproctus*) (Fig. 10.6).

Two modes of sperm transfer are found in *Tylototriton* (Table 10.2). In some species of *Tylototriton* sperm transfer is accomplished during pin-wheel circling (PWT; Rehberg 1986; Fleck 1992). In other *Tylototriton* species, however, the spermatophore is deposited directly under the female's cloaca (UFC) while

Table 10.2 Modes of display and sperm transfer in salamandrids. TFD = tail-fanning display, PWT = pin-wheel transfer, UFC = under female's cloaca, IFFS = in front of female's snout, MSL = march forward in a straight line, DOC = directly on female's cloaca. See text for description of each mode, and see Fig. 10.7 for the evolution of these courtship characters. References for each species are as listed in Table 10.1.

| Taxon | TFD | PWT | UFC | IFFS | MSL | DOC |
|-----------------------|-----|-----|-----|------|-----|-----|
| <i>Tylotriton</i> | 1 | 1 | 1 | 0 | 0 | 0 |
| <i>Salamandrina</i> | 0 | 1 | 0 | 0 | 0 | 0 |
| <i>Pleurodeles</i> | 1 | 1 | 0 | 0 | 0 | 0 |
| <i>Salamandra</i> | 0 | 0 | 1 | 0 | 0 | 0 |
| <i>Mertensiella</i> | 0 | 0 | 1 | 0 | 0 | 0 |
| <i>Chioglossa</i> | 0 | 0 | 1 | 0 | 0 | 0 |
| <i>Taricha</i> | 0 | 0 | 0 | 1 | 0 | 0 |
| <i>Notophthalmus</i> | 1 | 0 | 0 | 1 | 0 | 0 |
| <i>Triturus</i> | 1 | 0 | 0 | 1 | 0 | 0 |
| <i>Neureergus</i> | 1 | 0 | 0 | 0 | 1 | 0 |
| <i>Pachytriton</i> | 1 | 0 | 0 | 0 | 1 | 0 |
| <i>Cynops</i> | 1 | 0 | 0 | 0 | 1 | 0 |
| <i>Paramesotriton</i> | 1 | 0 | 0 | 0 | 1 | 0 |
| <i>Euproctus</i> | 1 | 0 | 0 | 0 | 0 | 1 |

the male holds the female in ventral amplexus (Dasgupta 1994). According to the analysis in Fig. 10.7, UFC in *Tylotriton* represents convergence with the sperm transfer mode found in *Salamandra* and its close relatives. One detail supporting this interpretation is that *Tylotriton* holds the female with one forelimb during sperm transfer, whereas *Salamandra*, *Mertensiella* and *Chioglossa* hold the female with both forelimbs. Both modes have yet to be observed in a single population of *Tylotriton*. Nevertheless, such bimodality seems likely and may yet be observed in one of the species of *Tylotriton* or *Echinotriton* with undescribed courtship.

Functions of amplexus. Amplexus appears to serve a number of functions. First, the reproductive coordination of the male and female is a function that is common to all species. Second, amplexus can facilitate pheromone delivery, particularly when males possess specialized glands on the head that produce courtship pheromones (e.g., in *Notophthalmus* and *Taricha*; Pool and Dent 1977; Smith 1941). Note, however, that pheromone delivery from male cloacal glands can take place outside of amplexus: for example, during the tail-nudging walk that precedes spermatophore deposition (e.g., *Cynops* and *Triturus*; Fig. 10.11). A third function of amplexus is to monopolize the female (*Taricha*, *Pleurodeles*, *Euproctus*). Amplexus can prevent other males from controlling the female (*Euproctus*, *Notophthalmus*), and amplexant males can transport the female away from rivals (*Taricha*, *Pleurodeles*) (Arnold 1977).

Tail-fanning display is ancient. The tail-fanning display (TFD) is another feature of extremely ancient origin in salamandrids. In the tail-fanning

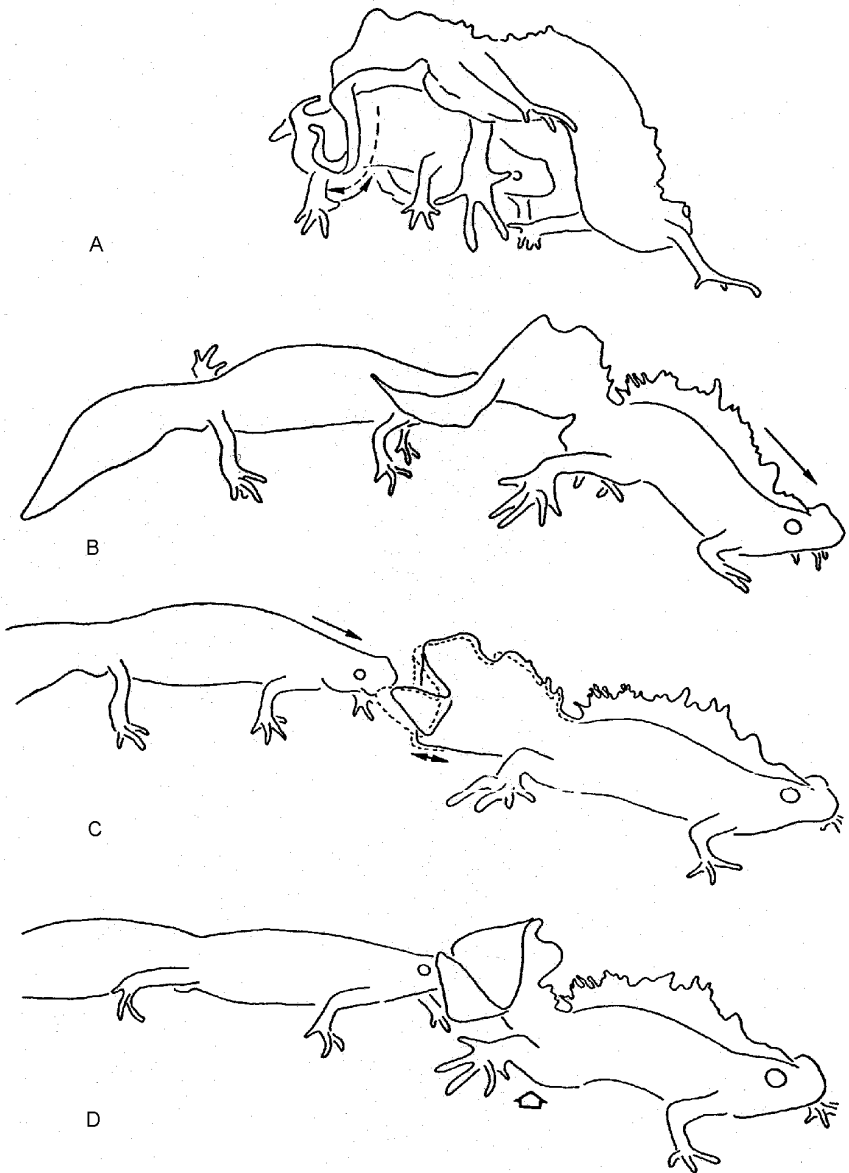

Fig. 10.8 Transition from tail-fanning display to spermatophore deposition in *Triturus cristatus*. From a 16 mm movie after Arnold, S.J. 1972. Ph.D. thesis, University of Michigan, Ann Arbor, Michigan, Fig. 54. **A.** The male executes the tail-fanning display while performing a handstand in front of the female. **B.** The male (right) moves away from the female (left) to position himself for an invitation to spermatophore deposition. **C.** The male pauses and vibrates his tail while holding it in a S-shaped position. The female is beginning to approach the male (0.0 sec). **D.** The female has touched the male's tail with her snout. The male is in the process of depositing a spermatophore (5.3 sec). Animals are of unknown origin.

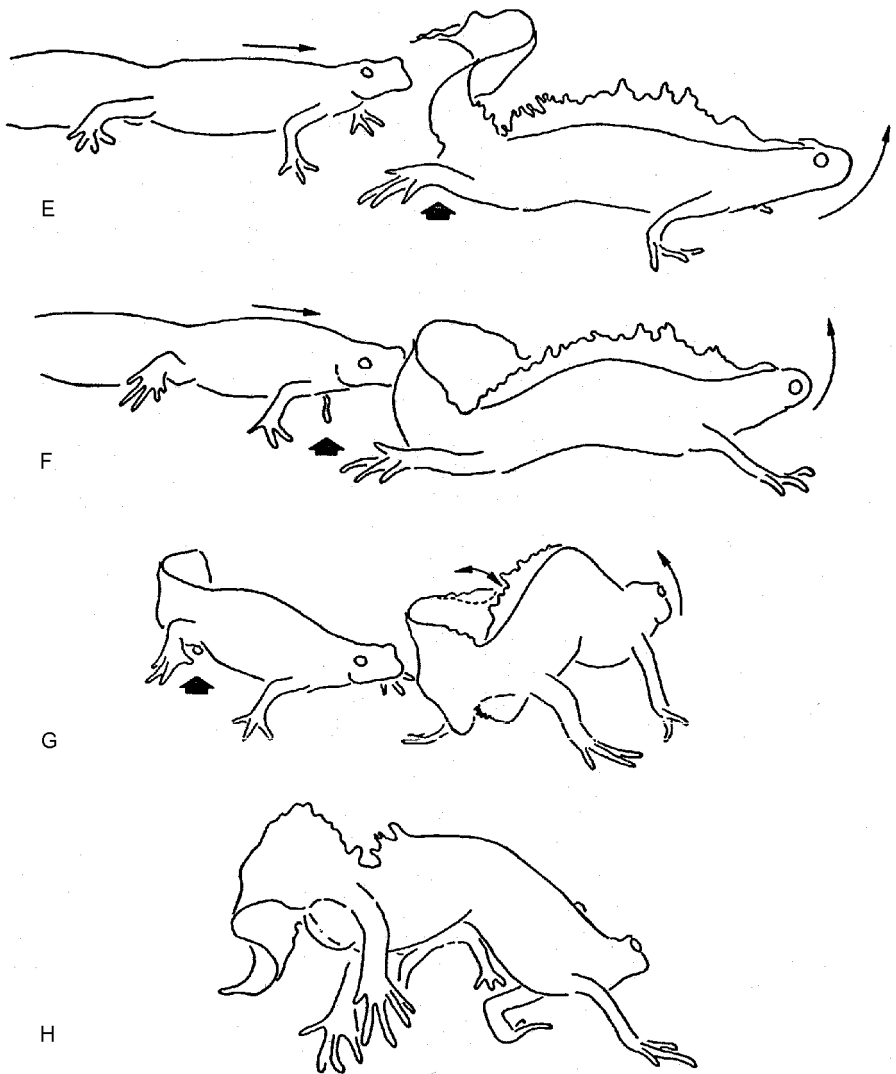

Fig. 10.9 Pivoting about one forelimb after spermatophore deposition in *Triturus cristatus*, continuation of Fig. 10.8. **E.** The male has completed spermatophore deposition and is pivoting about his left forelimb, swinging his cloaca in an arc away from the spermatophore (solid arrow) (14.0 sec). **F.** The male continues to pivot as the female moves forward over the spermatophore (18.1 sec). **G.** The female stops over the spermatophore as the male blocks her path, one body length in front of the spermatophore (25.2 sec). **H.** The female (behind male, mostly out of view) has successfully removed the sperm mass from the spermatophore. The male reverts to tail-fanning display (57.9 sec).

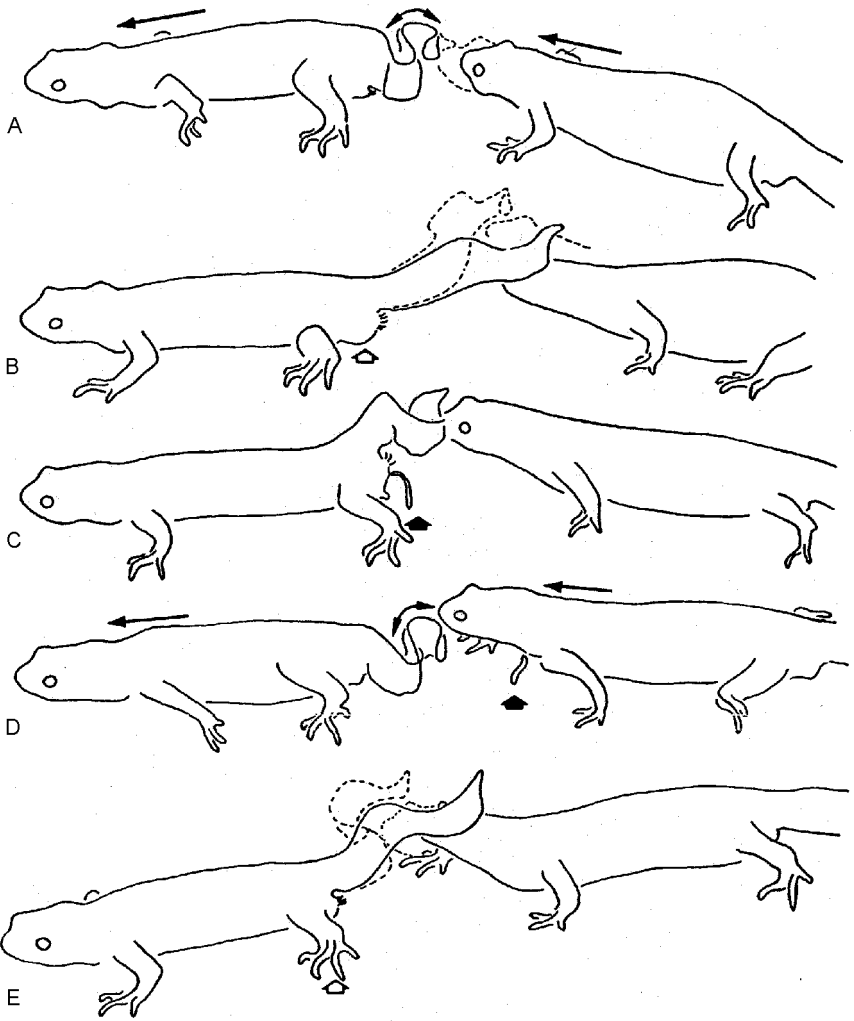

Fig. 10.10 The tail-nudging walk in *Cynops pyrhogaster*. From a 16 mm movie, total elapsed time 23.0 sec, after Arnold, S.J. 1972. Ph.D. thesis, University of Michigan, Ann Arbor, Michigan, Fig. 59. **A.** The pair moving forward in tail-nudging walk, with the male (left) holding his tail in characteristic S-shaped position (0 sec). **B.** The male deposits a spermatophore with the female stationary behind him (4.2 sec). **C.** The male lifts his vent off of the spermatophore (solid arrow) (9.9 sec). **D.** The male moves forward away from the spermatophore on a straight course. The female has moved over the spermatophore (11.2 sec). **E.** The male deposits a second spermatophore (open arrow), completing a cycle of events (23.0 sec). Animals are from Hiroshima, Japan.

display, the male's tail is recurved such that the distal portion is parallel to the tail base. Rapid fanning of the tail directs a water current past pheromone-releasing glands in the male's cloaca and towards the female's head. This

display is best known in the genus *Triturus* in which several varieties of fanning have been described (Halliday 1977; Arntzen and Sparreboom 1989; Halliday 1990). This display also is prominent in the courtships of various Asiatic and European newts (*Neurergus*, *Cynops*, *Pachytriton*, *Paramesotriton*, *Triturus*) (Fig. 10.7). In *Euproctus*, the display has been highly modified and is no longer used for pheromone transport. Instead, the male holds his tail vertically for long periods of time and then uses it to capture the female when she approaches or passes by (Guillaume 1999). The origin of the tail-fanning display apparently is more ancient than this clade, as it is performed in an abbreviated way by both *Pleurodeles* (Fig. 10.11) and *Tylototriton*. In all of these genera, the tail-fanning display is performed with the male positioned in front of -or to the side of- the female. A *Notophthalmus* male performs the tail-fanning display while holding the female about the neck with his hind limbs (Fig. 10.5). This display has been lost in the sister genus *Taricha*.

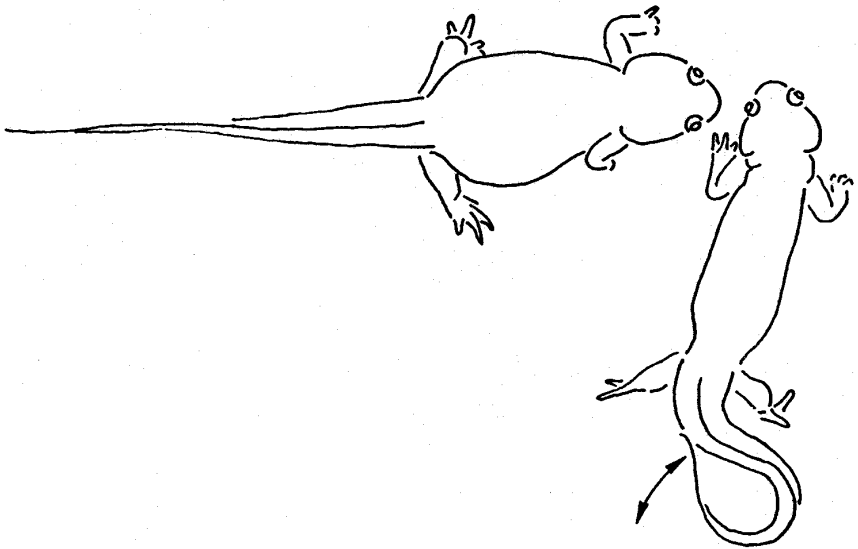

Fig. 10.11 Tail-fanning display in *Pleurodeles waltli*. From a photograph after Arnold, S.J. 1972. Ph.D. thesis, University of Michigan, Ann Arbor, Michigan, Fig. 63B. The male is on the right. Animals are laboratory animals descended from Gallien's stock and maintained at Wayne State University.

Ancestral courtship. Courtship in the ancestral salamandrid apparently consisted of: (1) ventral amplexus, with the male holding the female on his back by grasping her forelimbs with his forelimbs; (2) pin-wheel transfer of sperm, in which the male and female face each other, with the male locking one of his forelimbs around the ipsilateral forelimb of the female, and rotating through 180 degrees after spermatophore deposition; and (3) the male may have performed a tail-fanning display in front of the female as a prelude or alternative to amplexus. According to this interpretation, the tail-nudging

walk that precedes spermatophore deposition in *Notophthalmus*, *Triturus*, *Neureergus*, *Pachytriton*, *Cynops* and *Paramesotriton* is a derived feature. In other words, this tail-nudging walk is not homologous to the tail-straddling walk of plethodontids or to the cloaca-nudging walk of ambystomatids.

10.2.3 Courtship in the Proteidae

Courtship is known only in *Proteus* and has never been observed in *Necturus*. Courtship in *Proteus* lacks amplexus. The courtship sequence consists of an active approach phase by the male, tail-fanning display by the male, and finally a tail-nudging walk during which spermatophore deposition and sperm transfer occur (Chauvin 1883; Kemmerer 1912; Briegleb 1961, 1962). A few to several spermatophores are deposited during the course of a courtship. A sexually active male defends a territory from other males.

The courtship of *Proteus* most resembles the courtship of salamandrids, especially that of newts. Both Kemmerer (1912) and Briegleb (1962) describe tail-fanning by the male in which the male stands in front of the female and holds his tail in a recurved fashion. The effect is to fan a current of water towards the female's head. This kind of display is widely performed by salamandrids, but not by any other salamander family. Details of the tail-nudging walk that precedes and follows spermatophore deposition also suggest a relationship to salamandrids. In Briegleb's (1962) description, for example, the female nudges the lateral and dorsal parts of the male's tail base as the pair walks forward. This information is in contrast with details of the cloaca-nudging walk of ambystomatids (see below), in which the female nudges the male's cloaca and the male taps the female with his elevated tail. More detailed observations of *Proteus* (including photographs and videos) would help clarify similarities and differences in courtship activities.

10.2.4 Courtship in the Ambystomatidae

Ambystomatid courtship is notable for its simplicity, fast-paced action and abundance of spermatophores. These features presumably are related to the explosive breeding that typifies many *Ambystoma* species (Noble and Brady 1933; Kumpf 1934; Knudsen 1960; Anderson 1961; Arnold 1976; Downs 1978; Verrell and Pelton 1996; Verrell and Krenz 1998). The most common courtship consists of the following sequence of behaviors: (A) male approach to the female, nudging contact of her body, a cloaca-nudging walk (CNW: Fig. 10.12); (B) spermatophore deposition in front of the female's snout while the male faces away from the female; and (C) sperm transfer during a continuation of the cloaca-nudging walk, such that the female moves her cloaca over the spermatophore and inserts the sperm mass into her cloaca. Some ambystomatid species also include a dorsal amplexus (Fig. 10.13), or a shoving-transport of the female (Fig. 10.12); these behaviors occur between the initial nudging contact and the cloaca-nudging walk. A consistent characteristic of ambystomatid courtship is that many spermatophores are deposited in a single courtship.

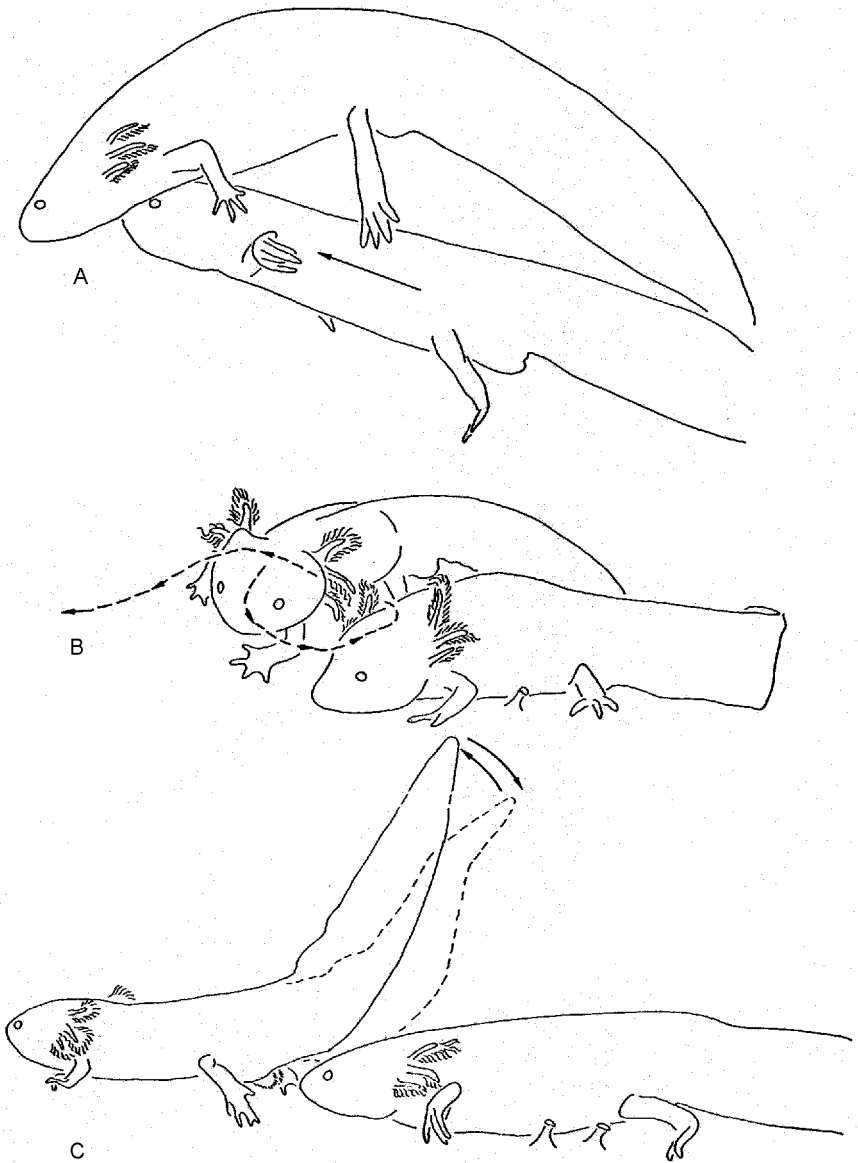

Fig. 10.12 Shoving and cloaca-nudging walk in *Ambystoma mexicanum*. From a 16 mm movie, total elapsed time 8.0 sec, after Arnold, S.J. 1972. Ph.D. thesis, University of Michigan, Ann Arbor, Michigan, Fig. 31. **A.** The male (below) lifts his head under the female's chest, shoving her through the water (0 sec). **B.** The male (left) rapidly rubs his head over the female's head and moves away from her (1.8-3.9 sec). **C.** The male (left) taps his tail on the female's head during the cloaca-nudging walk. Two spermatophores from earlier walks are visible against the female's abdomen. Animals are laboratory stock maintained at the University of Michigan.

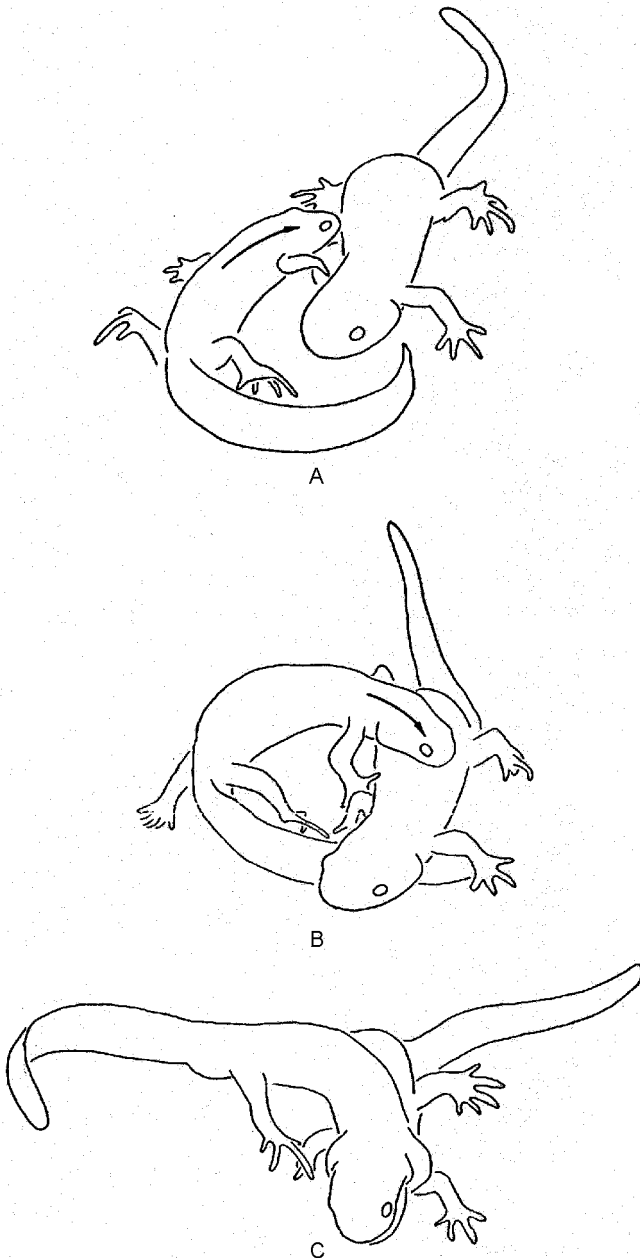

Fig. 10.13 Initiation of dorsal amplexus in *Ambystoma laterale*. From a 16 mm movie after Arnold, S.J. 1972. Ph.D. thesis, University of Michigan, Ann Arbor, Michigan, Fig. 35. **A.** Male (left) approaching a female and nudging her with his snout. **B.** The male (above) turns anterior as he moves along the female's dorsal surface. **C.** The male (above) in dorsal amplexus, clasping the female around her neck. Animals are from Livingston Co., Michigan.

Amplexus. The genus *Ambystoma* shows modest diversity in types of amplexus (Table 10.3, Fig. 10.14). The basic type is dorsal amplexus (DA) in which the male uses his forelimbs to grasp the female about her pectoral region (*A. gracile*, *A. laterale*, *A. jeffersonianum*, *A. macrodactylum*; Uzzell 1964; Licht 1969; Storez 1969; Licht and Bogart 1990) (Fig. 10.13). A variant of dorsal amplexus is performed in *A. gracile* in which the male uses his hind limbs to grasp the female about her pectoral region. Dorsal amplexus apparently has evolved four times in *Ambystoma* (Fig 10.14), but this result may reflect the lack of phylogenetic resolution in that cladogram. The distribution of dorsal amplexus suggests that *A. laterale*, *A. jeffersonianum*, and *A. macrodactylum* may be a natural group, and that this group may include the *gracile-maculatum* clade. As in aquatic-courting salamandrids that employ dorsal or ventral amplexus, *Ambystoma* males can use this type of amplexus to transport females away from rivals. No amplexus (NA) is found in many species of *Ambystoma*, including *A. maculatum*, *A. opacum*, *A. tigrinum*, and *A. mexicanum*. Shoving transport of females (STF, Fig. 10.12A) in *A. tigrinum* and relatives is used to transport females away from rivals (Arnold 1976). Terrestrial courtship (TC) has evolved in *A. opacum*, but –remarkably– without any apparent innovations in behavioral elements.

Table 10.3 Courtship behavior among species in the genus *Ambystoma*. DA = dorsal amplexus, STF = shoving transport of female, CNW = cloaca-nudging walk, and TC = terrestrial courtship. See text for more details, and see Fig. 10.14 for the evolution of these behaviors. References are listed below.

| Taxon | ref | DA | STF | CNW | TC |
|-----------------------|-----|----|-----|-----|----|
| <i>annulatum</i> | 1 | 0 | 0 | 0 | 0 |
| <i>barbouri</i> | 2 | 0 | 0 | 0 | 0 |
| <i>californiense</i> | 3 | 0 | 1 | 1 | 0 |
| <i>gracile</i> | 4 | 1 | 0 | 1 | 0 |
| <i>jeffersonianum</i> | 5 | 1 | 0 | 1 | 0 |
| <i>laterale</i> | 6 | 1 | 0 | 1 | 0 |
| <i>macrodactylum</i> | 7 | 1 | 0 | 1 | 0 |
| <i>maculatum</i> | 8 | 0 | 0 | 0 | 0 |
| <i>mexicanum</i> | 13 | 0 | 1 | 1 | 0 |
| <i>opacum</i> | 9 | 0 | 0 | 0 | 1 |
| <i>talpoideum</i> | 10 | 0 | 0 | 1 | 0 |
| <i>texanum</i> | 11 | 0 | 0 | 0 | 0 |
| <i>tigrinum</i> | 12 | 0 | 1 | 1 | 0 |

References: (1) Spotila 1976; Spotila and Beumer 1970; (2) Petranka 1998; (3) Arnold 1976; (4) Knudsen 1960; Licht 1969; (5) Uzzell 1964; (6) Kumpf and Yeaton 1932; Storez 1969; Arnold 1972; (7) Anderson 1961; Verrell and Pelton 1996; (8) Arnold 1976; (9) Noble and Brady 1933; Arnold 1972; (10) Shoop 1960; Verrell and Krenz 1998; (11) Wyman 1971; Arnold 1972; Downs 1978; Licht and Bogart 1990; (12) Kumpf 1934; Arnold 1976; Whiteman *et al.* 1994; (13) Arnold 1972.

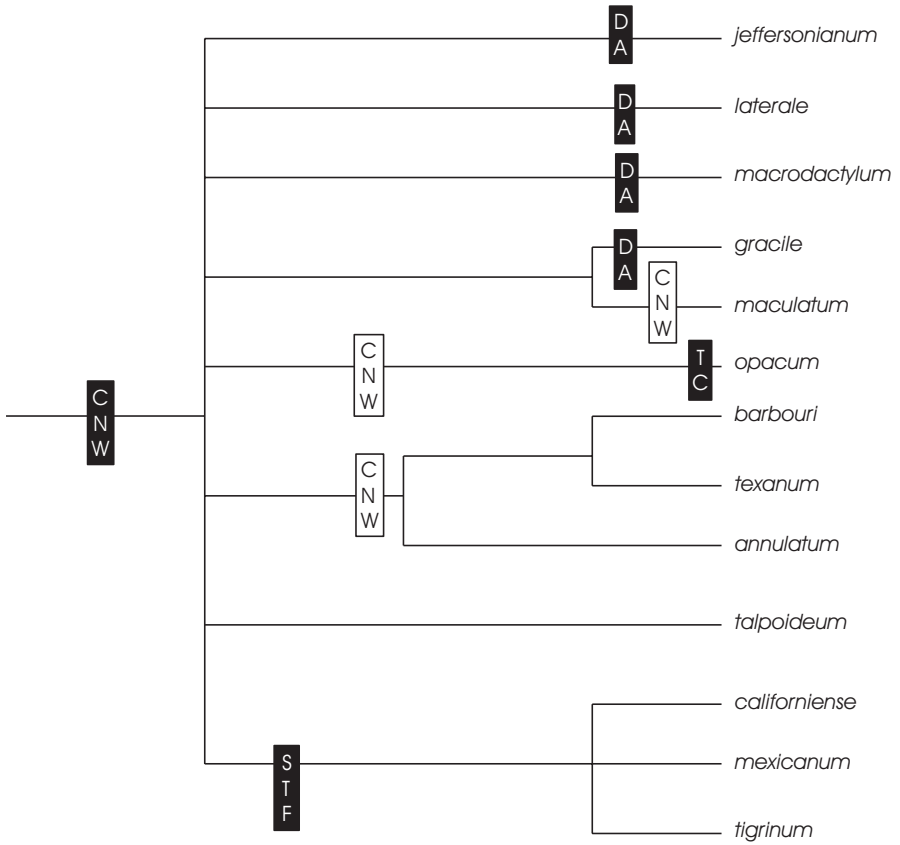

Fig. 10.14 Evolution of courtship characters in ambystomatids. Character origins are shown with solid boxes; losses are shown with open boxes. CNW = cloaca-nudging walk, DA = dorsal amplexus, STF = shoving transport of female, TC = terrestrial courtship. See Table 10.3 for distributions of characters among taxa. Cladogram after Larson *et al.* (Chapter 2, this volume).

Cloaca-nudging walk. As with the salamandrid tail-nudging walk, chemical communication probably takes place during the ambystomatid cloaca-nudging walk. During this walk, the female nudges the cloacal papillae of the male and undoubtedly receives chemical signals from him. The cloaca-nudging walk (CNW) apparently has been lost three times in the *Ambystoma* radiation (Fig. 10.14), but the actual number of times may turn out to be fewer once the phylogeny of the genus is better resolved. The species that lack an obvious CNW (*A. texanum*, *A. barbouri*, *A. annulatum*, *A. maculatum*, *A. opacum*) are characterized by explosive breeding in dense aggregations during a very short mating season. Courtship in these species is a frenzied affair in which some of the subtleties of communication between sexual partners have been jettisoned in the service of rapid spermatophore deposition (Arnold 1976). Whether these courtship frenzies are a grade or a clade remains to be established but, in either case, these frenzies appear to be a derived condition.

Ancestral courtship. Courtship in the ancestral ambystomatid consisted of an approach phase (in which the male rapidly nudged the female) and a tail-tapping display (in which the male faced away from the female and tapped her with his tail). The tail-tapping display constitutes an invitation to a cloaca-nudging walk. Spermatophore deposition and sperm transfer attempts are repeated ten or more times during the cloaca-nudging walk, with the male reverting to the approach phase if contact -and hence communication- is interrupted.

10.2.6 Courtship in the Dicamptodontidae

Dicamptodon courtship has not been observed. All that we know of courtship is that many spermatophores are deposited and that these resemble the spermatophores of *Ambystoma* (R. Nussbaum, personal communication).

10.2.7 Courtship in the Rhyacotritonidae

Courtship in the genus *Rhyacotriton* is incompletely known (Arnold 1972, 1977). Courtship begins with an approach phase in which the male nudges the female (Fig. 10.15). The male then faces away from the female and performs a peculiar tail-wagging display in which the tail is curled upwards over the male's back and the tail tip is wagged back and forth (Fig. 10.15). Presumably, this display represents an invitation to the female to engage in a tail-nudging, tail-straddling or cloaca-nudging walk. One or a few spermatophores are deposited on land during a courtship. In morphology, these spermatophores most resemble those of plethodontids.

10.2.8 Courtship in the Amphiumidae

Courtship is known from only one series of observations, made under less than ideal circumstances. Baker *et al.* (1947) observed courtship in an outdoor, aquatic enclosure. On four successive nights in June, two females and a male were observed swimming rapidly about together. The two females were also observed nudging the anterior portion of the male's body. On the fifth evening, one female slowly glided under the body of the male as he lay in shallow water, so that their bodies formed an acute angle. The female then rolled over and moved into a position with her cloaca in contact with the male's cloaca. The pair remained in this position for twenty minutes and then moved to deeper water. The authors found spermatozoa in the female's cloaca the following morning and concluded that they had observed sperm transfer via cloacal apposition. Sperm transfer has never been observed at close range in *Amphiuma*.

The proposed mode of sperm transfer is unlike all other urodeles having internal fertilization. Although the use of cloacal apposition to transfer a sperm mass to the female is also found in salamandrids (*Euproctus*), in that family the male grasps the female with his jaws and holds her with his hind limbs during the period of cloacal apposition (Fig. 10.6). Physical restraint is not

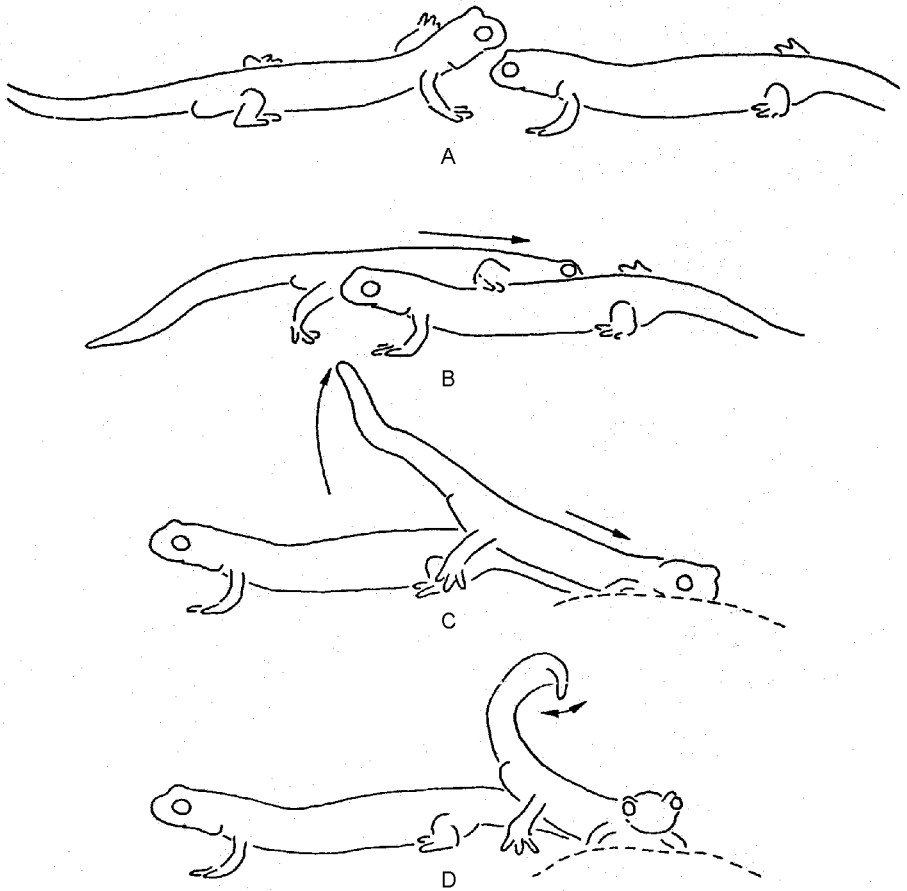

Fig. 10.15 Initiation of display behavior in *Rhyacotriton*. From a series of photographs after Arnold, S.J. 1972. Ph.D. thesis, University of Michigan, Ann Arbor, Michigan, Fig. 27. **A.** A male pauses after approaching a female. **B.** The male nudges the female as he moves along her body. **C.** The male moves away from the female and begins to curl his tail upward. **D.** The male performs a tail-wagging display with his tail curled upward. Animals are from Oregon.

possible for amphiumids, owing to the substantial reduction in limb size. Limb reduction in amphiumids apparently is correlated with highly modified courtship behavior.

10.3 COURTSHIP IN URODELE FAMILIES WITH EXTERNAL FERTILIZATION

Courtship behavior has best been described in the Hynobiidae as extensive observations have been made under both laboratory and field conditions. In

contrast, only a few observations of cryptobranchid courtship have been made (although both in the field and in the laboratory). The nature of sirenid reproduction is virtually unknown.

10.3.1 Courtship in the Hynobiidae

Observations of reproductive behavior have been made for species in three genera (*Hynobius*, *Ranodon*, *Salamandrella*), but not in other genera (*Batrachuperus*, *Liua*, *Onychodactylus*, *Paradactylodon*, *Pachyhynobius*, *Pseudohynobius*).

Oviposition. ‘Courtship’ is a misnomer for most hynobiids, because the male’s behavior is primarily directed towards recently laid eggs, rather than toward the female¹. In hynobiids, eggs are housed in two egg sacs that are joined together at their bases to form a structure like a tuning fork. The female begins oviposition by first attaching the common basal portion to a stone or branch. Once this base is secured, the female moves slowly away and the egg sacs are drawn out of each oviduct. Sometimes she is shoved away by the ardent male in his attempts to fertilize the eggs (Sasaki 1924; Hasumi 2001).

Male focus on egg sacs. In the most common sequence of ‘courtship’, the male is attracted to the female as she begins oviposition (Dybowski 1870; Sasaki 1924; Rehberg 1962; Thorn 1962, 1963, 1966a, 1972, 1986). He grasps the emerging egg sacs firmly with his forelimbs and hindlimbs and then releases sperm while arching his body in the dorso-ventral plane (Fig. 10.16). If rival males approach, the original male attempts to monopolize the eggs and their fertilization by maintaining his grasping position (Fig. 10.16). Despite such attempts at monopolization, multiple males may vie for fertilization of the eggs. Males may also guard the egg sacs after fertilization.

Amplexus. Mating behavior in the field involves scramble competition among males for access to egg sacs, and sometimes multiple males surround a single pair of egg sacs (Sato 1992; Usuda 1993; Hasumi 1994; Park *et al.* 1996; Park and Park 2000). In *Hynobius nigrescens*, males are territorial and defend oviposition sites (twigs) before females arrive (Usuda 1997). Behavioral observations of hynobiids provide some hints about how internal fertilization may have evolved in urodeles. Male *Hynobius* sometimes clasp the female during the process of oviposition. In *Hynobius nigrescens*, dorsal amplexus (with the male grasping the female with both fore- and hindlimbs) was observed in 81% of fertilization sequences (Hasumi 2001). This dorsal amplexus may be the primitive female-directed behavior from which other behaviors associated with internal fertilization were elaborated. However, note that our reconstruction of courtship in the ancestral salamander with internal fertilization (Fig. 10.14)

¹Because terminology has been inappropriately applied in descriptions of hynobiid reproduction, it may be useful to review correct nomenclature. ‘Fertilization’ is the event of sperm joining with eggs. Males may fertilize eggs, but they do not fertilize females. ‘Insemination’ is the act of transferring sperm inside the female’s body. In forms having external fertilization, the eggs are fertilized outside the female’s body. In such forms (*e.g.*, hynobiids), it is incorrect to say that the male inseminates the female because the sperm never enter her body.

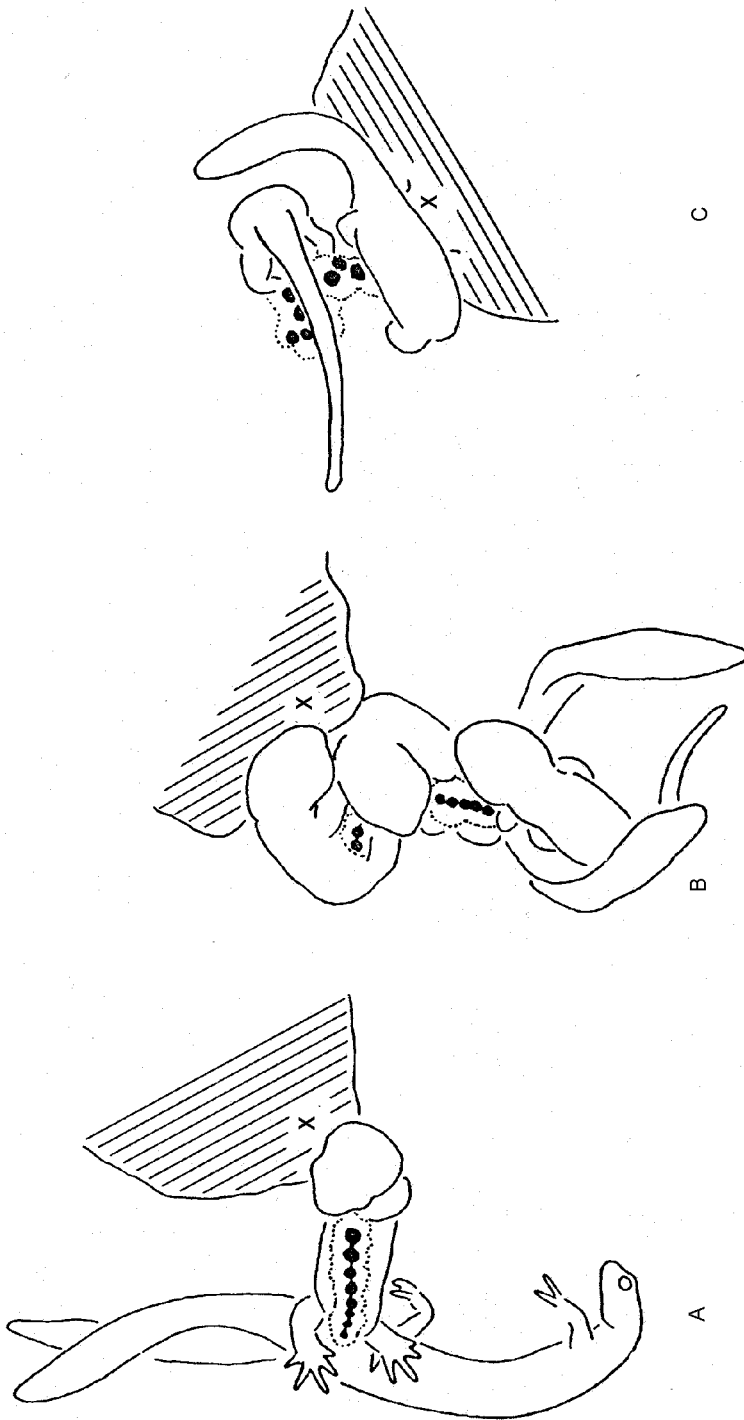

Fig. 10.16 Fertilization behavior in *Hynobius lichenatum*. After Sasaki, M., 1924, Journal of the College of Agriculture Hokkaido Imperial University 15: 12-23, Fig. 2. **A.** The female has attached the base of her eggsacs to a rock at the site marked X. The male clasps the egg sacs near their point of attachment with his forelimbs while applying his cloaca to the sacs and pushing the female away with his hindlimbs. **B.** The female has now completed oviposition and has moved off. Two additional males have arrived, so that three males clasp the egg sacs with both forelimbs and hindlimbs and attempt to fertilize the ova. **C.** Two males as they clasp another pair of egg sacs during fertilization. The site of attachment is indicated with an X.

indicates that this ancestor did not perform dorsal amplexus. Thus, if courtship with internal fertilization was elaborated from dorsal amplexus, amplexus was apparently lost early in the evolution of internal fertilization. Thus, the process of evolving internal fertilization remains obscure. Perhaps additional observations on hynobiids will clarify the transition.

Ranodon behavior. Early accounts of *Ranodon* females depositing egg sacs on spermatophores (Bannikov 1958, cited by Salthe 1967) appear to be in error. *Ranodon* mating behavior closely resembles that of *Hynobius* (Thorn 1986, 1987, 1994).

10.3.2 Courtship in the Cryptobranchidae

In *Cryptobranchus* and *Andrias*, males guard oviposition sites in burrows or under rocks. Females are attracted to these sites and lay large yolky eggs in long strands, as in the anuran genus *Bufo* (Kerbert 1904; Smith 1907; Kawamichi and Ueda 1998). Strands may be extruded from one oviduct or from both oviducts simultaneously. The resident male moves over the strands as they are laid and extrudes white, ropy masses of sperm, fertilizing the eggs. As in some hynobiids, the male may guard the eggs after fertilization. In the first field study of cryptobranchid reproduction, Kawamichi and Ueda (1998) found that only the very largest *Andrias* males in the population defended oviposition sites and spawned with females.

Detailed analysis of male movements during cryptobranchid fertilization are sorely needed, as are ethological comparisons with hynobiids. Apparently no aspect of cryptobranchid reproductive behavior has ever been photographed, filmed or otherwise illustrated. It is also remarkable that no observations have been published on *Cryptobranchus* mating behavior since 1907!

10.3.3 Courtship in the Sirenidae

Details of courtship behavior in sirenids are not known, although it is clear that these species have external fertilization. The feasibility of breeding sirenids in captivity has been established by Pfaff and Vause (2002). Given this success, it is surprising that no observations have been made on sirenid mating behavior. These animals are one of the most prominent components of amphibian communities in the American southeast.

10.4 CONCLUSIONS

10.4.1 Origin of Internal Fertilization

How many times did internal fertilization evolve in urodeles? External fertilization (EF) is almost surely the primitive state in urodeles, as indicated by the fact that the three most basal families (sirenids, cryptobranchids and hynobiids) all have external fertilization (Table 10.4, Fig. 10.17). Male guarding of eggs (MG) apparently evolved in the cryptobranchid-hynobiid line, after divergence from sirenids. Sharing of a large complex of derived characters by all other families of salamanders strongly supports the supposition that

Table 10.4 Distribution of courtship characters among the salamander families. MP = male pursuit of the female, EF = external fertilization, MG = male guarding of eggs, IF = internal fertilization, FS = few spermatophores deposited per courtship, MS = many (≥ 10) spermatophores deposited per courtship, SFF = spermatophore deposition in front of the female, TD = tail undulation, wagging or tapping display in front of the female. See Fig. 10.17 for the evolution of these behaviors.

| <i>Taxon</i> | <i>MP</i> | <i>EF</i> | <i>MG</i> | <i>IF</i> | <i>FS</i> | <i>MS</i> | <i>SFF</i> | <i>TD</i> |
|------------------|-----------|-----------|-----------|-----------|-----------|-----------|------------|-----------|
| Sirenidae | ? | 1 | ? | 0 | 0 | 0 | 0 | 0 |
| Cryptobranchidae | 0 | 1 | 1 | 0 | 0 | 0 | 0 | 0 |
| Hynobiidae | 0 | 1 | 1 | 0 | 0 | 0 | 0 | 0 |
| Rhyacotritonidae | 1 | 0 | 0 | 1 | 1 | 0 | ? | 1 |
| Plethodontidae | 1 | 0 | 0 | 1 | 1 | 0 | 1 | 1 |
| Amphiumidae | 1 | 0 | 0 | 1 | 1 | 0 | 0 | 0 |
| Proteidae | 1 | 0 | 0 | 1 | 1 | 0 | 1 | 1 |
| Salamandridae | 1 | 0 | 0 | 1 | 1 | 0 | 1 | 1 |
| Dicamptodontidae | ? | 0 | 0 | 1 | 0 | 1 | ? | ? |
| Ambystomatidae | 1 | 0 | 0 | 1 | 0 | 1 | 1 | 1 |

internal fertilization evolved once in salamanders. This complex of derived characters includes: (MP) male pursuit of the female; (TD) a tail display (fanning, wagging, tapping or undulation) in front of the female before spermatophore deposition; (FS) deposition of few (< 10 and probably 1-4) spermatophores during a courtship; (SFF) deposition of spermatophores in front of the female's snout; and, finally, (IF) internal fertilization (Table 10.4). This complex of characters was present in the ancestral courtship leading to internal fertilization. The deposition of many spermatophores in *Dicamptodon* and in ambystomatids is a derived condition, apparently associated with explosive breeding during a short season of reproduction. Amphiumids apparently have lost both tail display and spermatophore deposition in front of the female, although more courtship observations are sorely need to establish this.

10.4.2 Evolutionary Themes

Themes that are conspicuous in the evolution of salamander courtship are: (1) independence of courtship from adaptive zone; (2) long-term stasis of particular elements; (3) gradual modification of other elements; (4) loss of particular structures and behaviors; and (5) independent origin of similar behaviors and structures. Turning to the first of these themes, Salthe (1967) championed the hypothesis that salamander courtship evolved in relation to the physical environments in which courtship occurs. Although this idea appeals to the ecologist in each of us, virtually all of Salthe's (1967) ecological arguments have proven to be incorrect in the light of additional observations. What emerges, instead, is a picture of evolving courtship virtually uncoupled from the morphological adaptation that accompanies evolutionary transition

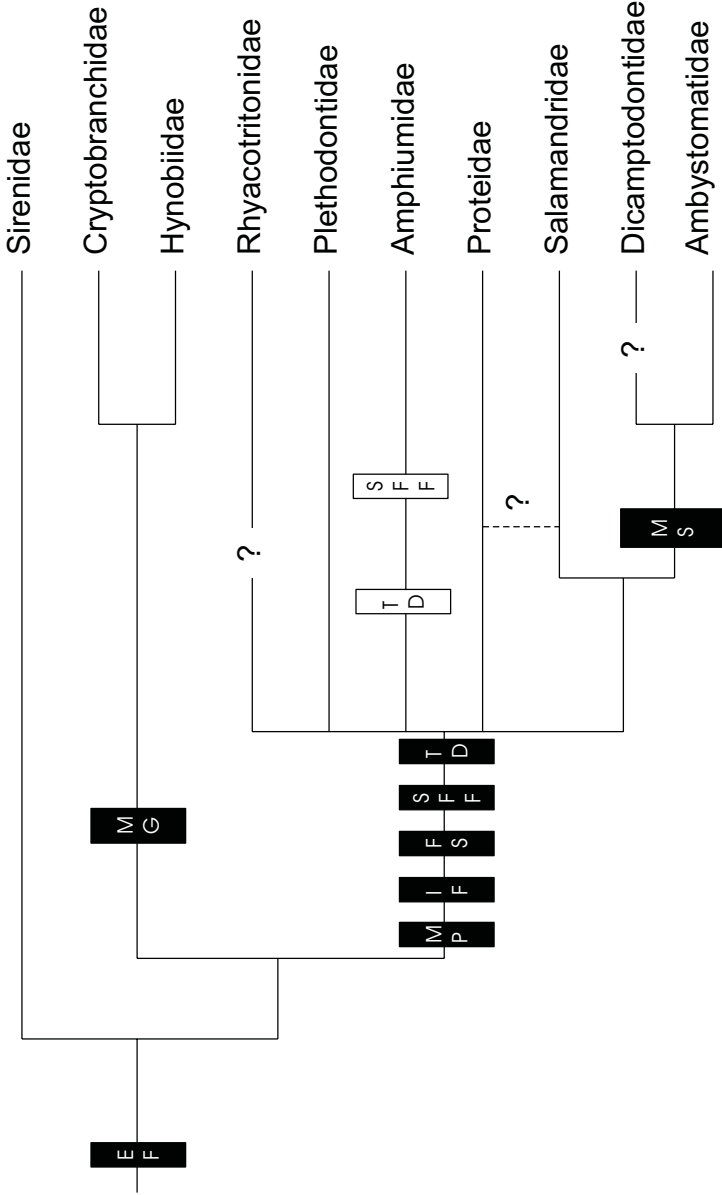

Fig. 10.17 Evolution of courtship characters among salamander families. Character origins are shown with solid boxes; losses are shown with open boxes. EF = external fertilization, MG = male guarding of eggs, MP = male pursuit of female, IF = internal fertilization, FS = few spermatophores per courtship, SFF = spermatophore deposition in front of female, TD = tail undulation, wagging or tapping display in front of the female, MS = many spermatophores deposited per courtship. See Table 10.4 for distributions of characters among taxa. Cladogram after Larson *et al.* (Chapter 2, this volume).

in adaptive zone. Consider the following instances in which closely related species have virtually identical courtship despite a difference in adaptive zone (indicated in parentheses): *Ambystoma maculatum* (aquatic) vs. *A. opacum* (terrestrial); *Ambystoma texanum* (pond) vs. *A. barbouri* (stream); *Eurycea bislineata* group (aquatic and terrestrial); *Euproctus asper* (aquatic) vs. *E. montanus* (terrestrial); and *Dendrotriton* (arboreal) vs. *Batrachoseps* (fossorial). Conversely, distantly related species in the same adaptive zone typically have courtships characteristic of their own clade. Thus, *Chioglossa lusitanica* (a salamandrid) and *Eurycea guttolineata* (a plethodontid) have remarkably similar morphologies and ecologies. Both species inhabit rocky crevices over water and drop into water to escape predators. Nevertheless, their courtships are completely different and are characteristic of their respective clades. The manifest independence of courtship from transitions in physical setting indicates that primary selective pressures on courtship are exerted by sexual partners and rivals. The physical environment has exerted minimal influence on the evolution of salamander courtship and mating.

10.4.3 Stasis

A second, major theme in salamander courtship evolution is long-term stasis in particular aspects of choreography. The tail-straddling walk of plethodontids, vaccination delivery of pheromones in plethodontids, ventral amplexus and pinwheel sperm transfer in salamandrids, the tail-fanning display of salamandrids, egg guarding by males in cryptobranchids and hynobiids – each of these behavioral complexes has been maintained in a virtually unaltered state for tens of millions of years. What processes are implied by this stability? Charlesworth *et al.* 1984 have persuasively argued that developmental constraints are incapable of accounting for such long-term stability. An alternative explanation is long, persistent stabilizing selection. In this view, the interaction of sexual partners helps generate a version of stabilizing selection (*viz.*, correlational selection). The tail-straddling walk of plethodontids is the outcome of a tactual communication system that involves both male and female (Arnold 1976). Deviations in the behavior of either sexual partner apparently throws the system out of kilter and thus are opposed by correlational selection.

10.4.4 Gradual Modification

In contrast to the stasis of major aspects of choreography, minor courtship components often show gradual, step-by-step modification. Variations in the tail-fanning displays of *Triturus* often are species-specific but are easily derived from one another by subtle changes in the amplitude and tempo of tail movements (Halliday 1977, 1990; Arntzen and Sparreboom 1989). The origin of a peculiar, circular tail-straddling walk in *Aneides* can be accounted for by prolonging the “turning back” behavior that is used by most plethodontid males to deliver courtship pheromones (Sapp 2002).

10.4.5 Rates of Evolution

Portions of the courtship sequence devoted to sperm transfer are prone to stasis, whereas the early phases of courtship are more prone to rapid evolution (Arnold 1977). Thus, sperm transfer modes within plethodontids, within ambystomatids and within particular clades of salamandrids are remarkably stable. Even when salamandrids change sperm transfer modes, they tend to retain the trait of pivoting about one forelimb after spermatophore deposition. In contrast, the behavioral variations that have been documented among species in *Desmognathus*, *Plethodon*, and *Triturus* mainly involve display elements performed early in the courtship sequence (Arntzen and Sparreboom 1989; Marvin and Hutchison 1996; Verrell 1999). These differences in stability imply that the later stages are under strong stabilizing selection, whereas the early stages are subject to episodes of directional selection.

10.4.6 Loss of Behavior

The loss of behaviors and morphological structures is a common theme in salamander courtship evolution. Plethodontids show repeated loss of a complex that includes mental glands, protruding premaxillary teeth and pheromone delivery behaviors (Houck and Sever 1994). In earlier discussions, we mentioned the loss of multiple behaviors in *Amphiuma* and *Euproctus*, the loss of 90 degree pivoting in the Asiatic newt clade, and the independent losses of pinwheel sperm transfer and head-to-head posture (PWT and HTH) in two different salamandrid clades. The frequency of these losses underscores the need for phylogenetic analysis of behavior. Only with a robust phylogeny can one distinguish whether a trait has been lost or is primitively absent.

10.4.7 Behavioral Convergence

Phylogenetic analysis also reveals a few cases of independent origin of behaviors that appear to be strikingly similar. Dorsal amplexus apparently has evolved three times: in *Ambystoma*, in *Salamandra*, and in *Taricha-Notophthalmus*. Chin-rubbing in *Taricha* (Davis and Twitty 1964; Fig. 10.4) represents convergence to a similar behavior in various plethodontids (Houck and Sever 1994). Spermatophore deposition under the female's cloaca evolved independently in *Tylotriton* and in the *Salamandra-Chioglossa-Mertensiella* clade. Biting restraint of females evolved independently in *Desmognathus aeneus* and *D. wrighti* and a third time in *Euproctus*.

10.4.8 Model for Behavioral Transitions

How were major evolutionary transitions in courtship accomplished? One mode, discussed in previous sections, is to add an element, call it B, so that courtship has a facultative bifurcation. The individual, bimodal courtship can now proceed either along the ancestral path (A) or along the derived path (B). In the next evolutionary step, the ancestral path A is deleted, so that courtship reverts from bimodal to unimodal. The bimodal, evolutionary model is $A \rightarrow (A \text{ or } B) \rightarrow B$. Thus, the presence of facultative amplexus in *Notophthalmus*

may provide an intermediate state for the loss of amplexus in the Asiatic-European newt clade. The presence of facultative slapping delivery in the *Plethodon glutinosus* clade may provide an intermediate for the loss of pheromone delivery in *Ensatina* and other plethodontines. In both of these cases, however, the intermediate is hypothetical since the intermediate taxon is not in the lineage in question. The bimodal model also directs attention to those courtships with bifurcations and to the causes of those bifurcations. Perhaps the bimodal model will also help with the many unresolved mysteries that remain in salamander courtship evolution: e.g., the transition from external to internal fertilization, the transition to direct sperm transfer in *Euproctus*, and the origin of pinwheel sperm transfer in salamandrids.

10.5 FUTURE DIRECTIONS

This review has highlighted the need for observations of courtship and mating in poorly documented families: Sirenidae, Amphiumidae, Proteidae (*Necturus*), Rhyacotritonidae, and Dicamptodontidae. The absence of information about *Necturus* is especially surprising given that this animal is routinely used to teach vertebrate anatomy in the United States. How is it possible that we know so little about its reproductive biology?

Even when accounts of courtship exist, there remains a pressing need for detailed accounts illustrated with photographs and figures. Without accounts of behavior that are illustrated and precise, it is virtually impossible to recognize homologies. Establishing an archive (website) of photographs, film and video of salamander courtship behaviors would be a useful enterprise.

There is an obvious need for better resolution of the phylogeny of salamanders, especially the deep branches. Many of the evolutionary inferences that we have made in this article may be overturned as phylogenies attain better resolution. At the same time comparative analysis of courtship may help resolve some phylogenetic issues. The relationship of *Proteus* and *Necturus*, for example, may be clarified by observations of *Necturus* courtship.

Finally, we would like to stress the need for collaborations between behaviorists, systematists, physiologists, morphologists and biochemists. Many issues in the study of salamander courtship involve communication by chemical, visual, and tactile mechanisms, which, by their nature, require a team approach for thorough analyses. Likewise, the elucidation of sexual competition virtually demands the use of molecular markers used to diagnose paternity. The clarification of phylogenetic relationships is a never-ending process that is best pursued with behavioral, morphological and molecular tools.

10.6 ACKNOWLEDGEMENTS

We conducted our observations of salamander courtship behavior at the following institutions, and with facilities provided by the individuals listed: Univ. of Michigan Museum of Zoology (N. Hairston), Univ. Michigan

Botanical Garden (W. Wagner), Museum of Vertebrate Zoology (D. Wake), Mountain Lake Biological Station (J. Murray), and Highlands Biological Station (R. Bruce, R. Wyatt). We are grateful to George Nace, Christina Richards and John Taylor for the use of laboratory stocks of *Ambystoma* and *Pleurodeles*. We thank T. Halliday, A. Kluge, D. Sever, M. Sparreboom, R. Thorn and P. Verrell for helpful discussions. We are grateful to A. de Ricqlès, J. Joly, B. Sanchiz, J. P. Martinez Rica, G. Malacarne and G. Mancino for hosting our field work in France, Spain and Italy. We also thank our former and current students for their many hours of observing courtship behavior: E. Adams, A. Bell, L. Dyal, E. R. Fox, N. Griffith, C. Palmer, D. Promislow, N. Reagan, S. Rollmann, M. Rudenko, J. Sapp and R. Steinberg. Continued collaboration on salamander courtship behavior with Richard Feldhoff and Pamela Feldhoff is greatly appreciated. This work was supported in part by grants from the Spencer Foundation and the National Science Foundation grants BNS-8014151, BSR-8800888, BSR-8906703, BSR-8506766, BSR-8906703, and IBN-0110666.

10.7 LITERATURE CITED

- Ahrenfeldt, R.H. 1955. Mating behaviour of *Euproctus asper* in captivity. *British Journal of Herpetology* 2: 194-197.
- Anderson, J.D. 1961. The courtship behavior of *Ambystoma macrodactylum croceum*. *Copeia* 1961: 132-139.
- Arnold, S.J. 1972. The evolution of courtship behavior in salamanders. Ph.D. thesis, University of Michigan, Ann Arbor, Michigan. 570 pp.
- Arnold, S.J. 1976. Sexual behavior, sexual interference, and sexual defense in the salamanders *Ambystoma maculatum*, *Ambystoma tigrinum* and *Plethodon jordani*. *Zeitschrift für Tierpsychologie* 42: 247-300.
- Arnold, S.J. 1977. The courtship behavior of North American salamanders with some comments on Old World salamandrids. Pp. 141-183. In D. H. Taylor and S. I. Guttman (eds), *The Reproductive Biology of Amphibians*. Plenum Press, New York, NY.
- Arnold, S.J. 1987. The comparative ethology of courtship in salamandrid salamanders. 1. *Salamandra* and *Chioglossa*. *Ethology* 74: 133-145.
- Arnold, S.J. and Houck, L.D. 1982. Courtship pheromones: evolution by natural and sexual selection. Pp. 173-211. In M. Nitecki (ed), *Biochemical Aspects of Evolutionary Biology*. University of Chicago Press, Chicago, Illinois.
- Arntzen, J.W. and Sparreboom, M. 1989. A phylogeny of the Old World newts, genus *Triturus*: biochemical and behavioural data. *Journal of Zoology, London* 219: 645-664.
- Baker, C.L., Baker, L.C. and Caldwell, M.F. 1947. Observation of copulation in *Amphiuma tridactylum*. *Journal of the Tennessee Academy of Science* 22: 87-88.
- Bannikov, A.G. 1958. Die Biologie des Froschzahnmolches *Ranodon sibiricus* Kessler. *Zoologische Jahrbucher, Abteilung für Systematik Oekologie und Geograaphie der Teire*, Jena 86: 245-252.
- Bedriaga, J. von. 1882a. Über die Begattung bei einigen geschwanzten Amphibien. *Zoologischer Anzeiger* 5: 357-359.

- Bedriaga, J. von. 1882b. Über die Begattung bei einigen geschwanzten Amphibien. *Zoologischer Anzeiger* 5: 265-268.
- Bedriaga, J. von. 1883. Beiträge zur Kenntnis der Amphibien und Reptilien der Fauna von Korsika. *Archiv Freunde der Naturgeschichte in Mecklenburg* 49: 201-273.
- Bennett, A.F. and Houck, L.D. 1983. The energetic cost of courtship and aggression in a plethodontid salamander. *Ecology* 64: 979-985.
- Briegleb, W. 1961. Die Spermatophore des Grottenolms. *Zoologischer Anzeiger*. 166: 87-91.
- Briegleb, W. 1962. Zur Biologie und Ökologie des Grottenolms (*Proteus anguinus* Laur. 1768). *Zeitschrift für Morphologie Ökologie Tiere* 51: 271-334.
- Charlesworth, B., Lande, R. and Slatkin, M. 1982. A neo-Darwinian commentary on macroevolution. *Evolution* 36: 474-498.
- Chauvin, N. von. 1883. Die Art der Fortpflanzung des *Proteus anguinus*. *Zeitschrift für Wissenschaftliche Zoologie* 38: 671-685.
- Dasgupta, R. 1994. Courtship in the Himalayan salamander. *Annals of the Bengal Natural History Society, New Series* 13: 23-36.
- Davis, W.C. and Twitty, V.C. 1964. Courtship behavior and reproductive isolation in the species of *Taricha* (Amphibia, Caudata). *Copeia* 1964: 601-610.
- Despax, R. 1923. Contribution à l'étude anatomique et biologique des Batraciens Urodeles du groupe des Euproctes et spécialement de l'Euprocte des Pyrénées *Triton (Euproctus) asper* Dugès. *Bulletin Societe d'Histoire Naturelle de Toulouse* 51: 185-440.
- Downs, F.L. 1978. Unisexual *Ambystoma* from the Bass Islands of Lake Erie. *Occasional Papers of the Museum of Zoology, University of Michigan* 685: 1-36.
- Dybowski, B. 1870. Beitrag zur Kenntnis der Wassermolche Sibiriens. *Verhandlungen, Zoologisch-Botanische Gesellschaft in Wien* 20: 237-242.
- Fleck, J. 1992. Haltung und Nachzucht von *Tylotriton kweichowensis*. *Salamandra* 28: 97-105.
- Gallien, L. 1953. Elevage et comportement du Pleurodele au laboratoire. *Bulletin Societe Zoologique de France* 77: 456-461.
- Guillaume, O. 1999. Does the Pyrenean salamander *Euproctus asper* use chemical cues for sex identification and mating behaviour? *Behavioural Processes* 46: 57-62.
- Halliday, T.R. 1975. An observational and experimental study of sexual behaviour in the smooth newt, *Triturus vulgaris* (Amphibia: Salamandridae). *Animal Behaviour* 23: 291-322.
- Halliday, T.R. 1976. The libidinous newt. An analysis of variations in the sexual behavior of the male smooth newt, *Triturus vulgaris*. *Animal Behaviour* 24: 398-414.
- Halliday, T.R. 1977. The courtship of European newts: an evolutionary perspective. Pp. 185-232. In D. H. Taylor and S. I. Guttman (eds), *The Reproductive Biology of Amphibians*. Plenum Press, New York, NY.
- Halliday, T.R. 1990. The evolution of courtship behavior in newts and salamanders. *Advances in the Study of Behavior* 19: 137-169.
- Hasumi, M. 1994. Reproductive behavior of the salamander *Hynobius nigrescens*: monopoly of egg sacs during scramble competition. *Journal of Herpetology* 28: 264-267.
- Hasumi, M. 2001. Sexual behavior in female-biased operational sex ratios in the salamander *Hynobius nigrescens*. *Herpetologica* 57: 396-406.

- Highton, R. and Larson, A. 1979. The genetic relationships of the salamanders of the genus *Plethodon*. *Systematic Zoology* 28: 579-599.
- Highton, R. and Peabody, R.B. 2000. Geographic protein variation and speciation in salamanders of the *Plethodon jordani* and *Plethodon glutinosus* complexes in the southern Appalachian Mountains with the descriptions of four new species. Pp. 31-94. In R. C. Bruce, R. G. Jaeger and L. D. Houck (eds), *The Biology of Plethodontid Salamanders*. Plenum Press, New York, NY.
- Himstedt, W. 1979. The significance of color signals in partner recognition of the newt *Triturus alpestris*. *Copeia* 1979: 40-43.
- Houck, L.D. 1980. Courtship behavior in the plethodontid salamander *Desmognathus wrighti*. *American Zoologist* 20: 825A.
- Houck, L.D. 1986. The evolution of salamander courtship pheromones. Pp. 173-190. In D. Duvall, D. Muller-Schwarze and R. M. Silverstein (eds), *Chemical Signals in Vertebrates, Vol. 4*. Plenum Press, New York, NY.
- Houck, L.D., Bell, A.M, Reagan-Wallin, N.L. and Feldhoff, R.C. 1998. Effects of experimental delivery of male courtship pheromones on the timing of courtship in a terrestrial salamander, *Plethodon jordani* (Caudata: Plethodontidae). *Copeia* 1998: 214-219.
- Houck, L.D. and Reagan, N.L. 1990. Male courtship pheromones increase female receptivity in a plethodontid salamander. *Animal Behaviour* 39: 729-734.
- Houck, L.D. and Sever, D.M. 1994. The role of the skin in reproduction and behavior. Pp. 351-381. In H. Heatwole and G. Barthalamus (eds), *Amphibian Biology, Vol. 1, The Integument*. Surrey Beatty and Sons, Chipping Norton, NSW, Australia.
- Houck, L.D. and Verrell, P.A. 1993. A review of courtship behavior in plethodontid salamanders. *Herpetologica* 49: 175-184.
- Joly, J. 1966. Sur l'éthologie sexuelle de *Salamandra salamandra* (L.). *Zeitschrift für Tierpsychologie* 23: 8-27.
- Kawamichi, T. and H. Ueda. 1998. Spawning at nests of extra-large males in the Giant Salamander *Andrias japonicus*. *Journal of Herpetology* 32: 133-136.
- Kemmerer, P. 1912. Experimente über Fortpflanzung, Farbe, Augen und Körperreduction bei *Proteus anguinus* Laur. *Archiv für Entwickelungsmechanik* 33: 349-459.
- Kerbert, G. 1904. Zur Fortpflanzung von *Megalobatrachus maximus* Schlegel. *Zoologischer Anzeiger* 27: 305-320.
- Knudsen, J.W. 1960. The courtship and egg mass of *Ambystoma gracile* and *Ambystoma macrodactylum*. *Copeia* 1960: 44-46.
- Kumpf, K.F. 1934. The courtship of *Ambystoma tigrinum*. *Copeia* 1934: 7-10.
- Kumpf, K.F. and Yeaton, S.C. 1932. Observations on the courtship behavior of *Ambystoma jeffersonianum*. *American Museum Novitates* 546: 1-7.
- Larson, A., Wake, D.B., Maxson, L.R. and Highton, R. 1981. A molecular phylogenetic perspective on the origins of morphological novelties in the salamanders of the tribe Plethodontini. (Amphibia, Plethodontidae). *Evolution* 35: 405-422.
- Licht, L. 1969. Observations on the courtship behavior of *Ambystoma gracile*. *Herpetologica* 25: 49-52.
- Licht, L. and Bogart, J.P. 1990. Courtship behavior of *Ambystoma texanum* on Pelee Island, Ontario. *Journal of Herpetology* 24: 450-452.
- Maksymovitch, E. and Verrell, P. 1992. Courtship behavior of the Santeetlah dusky salamander, *Desmognathus santeetlah* Tilley (Amphibia: Caudata: Plethodontidae). *Ethology* 90: 236-246.

- Marks, S.B. and Houck, L.D. 1989. Partial cost of spermatophore production in the salamander *Desmognathus ochrophaeus*. *Journal of Herpetology* 23: 81-84.
- Marvin, G. and Hutchison, V.H. 1996. Courtship behavior of the Cumberland Plateau woodland salamander, *Plethodon kentucki* (Amphibia: Plethodontidae) with a review of courtship in the genus *Plethodon*. *Ethology* 102: 285-303.
- Mead, L.S. and Verrell, P.A. 2002. Evolution of courtship behaviour patterns and reproductive isolation in the *Desmognathus ochrophaeus* complex. *Ethology* 108: 403-427.
- Noble, G.K. and Brady, M.K. 1933. Observations on the life history of the marbled salamander, *Ambystoma opacum*. *Zoologica* 11: 89-132.
- Obst, F.J. von and Rotter, J. 1962. Notizen zu *Mertensiella caucasica* (Waga 1876). *Aquarien Terrarien Zeitschrift (Datz)* 15: 50-52, 84-86.
- Park, D. and Park, S.R. 2000. Multiple insemination and reproductive biology of *Hynobius leechii*. *Journal of Herpetology* 34: 594-598.
- Park, S.R., Park, D.S. and Yang, S.Y. 1996. Courtship, fighting behaviors and sexual dimorphism of the salamander, *Hynobius leechii*. *Korean Journal of Zoology* 39: 437-446.
- Petranka, J.W. 1998. *Salamanders of the United States and Canada*. Smithsonian Institution Press, Washington, D.C. 587 pp.
- Pfaff, C.S. and Vause, K.B. 2002. Captive reproduction and growth of the Broad-Striped Dwarf Siren (*Pseudobranchius s. striatus*). *Herpetological Review* 33: 42-44.
- Pool, T.B. and Dent, J.N. 1977. The ultrastructure and the hormonal control of product synthesis in the hedonic glands of the red-spotted newt *Notophthalmus viridescens*. *Journal of Experimental Zoology* 201: 177-202.
- Promislow, D.E.L. 1987. Courtship behavior of a plethodontid salamander, *Desmognathus aeneus*. *Journal of Herpetology* 21: 203-220.
- Rehberg, F. 1962. Beobachtungen über die Fortpflanzung des *Hynobius nebulosus*. *Mitteilungsblatt Salamander Gesellschaft für Terrarien* Buchloe 9: 62-63.
- Rehberg, F. 1986. Haltung und Zucht der Krokodilmolches *Tyrototriton verrucosus* Anderson 1871. *Herpetofauna* 8: 11-17.
- Rollmann, S.M., Houck, L.D. and Feldhoff, R.C. 1999. Proteinaceous pheromone affecting female receptivity in a terrestrial salamander. *Science* 285: 1907-1909.
- Ruben, J.A., Reagan, N.L., Verrell, P.A. and Boucot, A.J. 1993. Plethodontid salamander origins: A response to Beachy and Bruce. *The American Naturalist* 142: 1038-1051.
- Salthe, S.E. 1967. Courtship patterns and the phylogeny of the urodeles. *Copeia* 1967: 100-117.
- Sapp, J. 2002. Courtship behaviors in the salamander genus *Aneides*. M.S. thesis. Oregon State University, Corvallis, Oregon. 94 pp.
- Sasaki, M. 1924. On a Japanese salamander in Lake Kuttarush which propagates like the axolotl. *Journal of the College of Agriculture Hokkaido Imperial University* 15: 12-23.
- Sato, T. 1992. Reproductive behavior in the Japanese salamander *Hynobius retardatus*. *Japanese Journal of Herpetology* 14: 184-190.
- Sawada, S. 1963. Studies on the local races of the Japanese newt, *Triturus pyrrhogaster* Boie, II. Sexual isolation mechanisms. *Journal of Science, Hiroshima University, Series B, Division 1, Zoology* 21:167-180.
- Sever, D.M. 2000. Sperm storage in female plethodontid salamanders with especial reference to desmognathines. Pp. 345-369. In R. C. Bruce, L. D. Houck and R. Jaeger (eds), *Biology of the Plethodontid Salamanders*. Plenum Press, New York, NY.

- Shoop, C.R. 1960. The breeding habits of the mole salamander, *Ambystoma talpoideum* (Holbrook), in southeastern Louisiana. *Tulane Studies in Zoology* 8: 65-82.
- Smith, B.G. 1907. The life history and habits of *Cryptobranchus allegheniensis*. *Biological Bulletin* 13: 5-39.
- Smith, R.E. 1941. Mating behavior in *Triturus torosus* and related newts. *Copeia* 1941: 255-262.
- Sparreboom, M. 1986. Courtship in newts of the genus *Triturus* and *Paramesotriton*. Pp. 529-534. In Z. Rocek (ed), *Studies in Herpetology*. Charles University, Prague, Czech Republic.
- Sparreboom, M. 1997. Sexual behaviour of the Chinese fire-bellied newt, *Cynops orientalis*. *Amphibia-Reptilia* 18: 27-38.
- Sparreboom, M., Steinfartz, S. and Schultschik, G. 2000. Courtship behaviour of *Neurergus* (Caudata: Salamandridae). *Amphibia-Reptilia* 21: 1-11.
- Spotila, J.R. 1976. Courtship behavior of the ringed salamander (*Ambystoma annulatum*): observations in the field. *The Southwestern Naturalist* 21: 412-413.
- Spotila, J.R. and Beumer, R.J. 1970. The breeding habits of the ringed salamander, *Ambystoma annulatum* (Cope), in northwestern Arkansas. *The American Midland Naturalist* 84: 77-89.
- Stebbins, R.C. 1949. Courtship of the plethodontid salamander *Ensatina eschscholtzii*. *Copeia* 1949: 274-281.
- Storez, R.A. 1969. Observations on the courtship of *Ambystoma laterale*. *Journal of Herpetology* 3: 87-95.
- Sullivan, B.K., Ryan, M.J. and Verrell, P.A. 1995. Female choice and mating system structure. Pp. 489-517. In H. Heatwole and B.K. Sullivan (eds), *Amphibian Biology, Volume 2, Social Behaviour*. Surrey Beatty and Sons, Chipping Norton, NSW, Australia.
- Thiesmeier, B. and Hornberg, C. 1997. Paarung, Fortpflanzung und Larvalentwicklung von *Pachytriton* sp. (*Pachytriton* A) nebst Bemerkungen zur Taxonomie der Gattung. *Salamandra* 33: 97-110.
- Thorn, R. 1962. Protection of a brood by a male salamander, *Hynobius nebulosus*. *Copeia* 1962: 638-640
- Thorn, R. 1963. Contribution à l'étude d'une salamandre japonaise, l'*Hynobius nebulosus* (Schelegel). Comportement et reproduction en captivité. *Archives (Nouvelle Série) de l'Institut Grand-Ducal de Luxembourg, Section des Sciences Naturelles, Physiques et Mathématique* 29: 201-215.
- Thorn, R. 1966a. Nouvelles observations sur l'éthologie sexuelle de l'*Hynobius nebulosus* (Temminck et Schlegel)(Caudata, Hynobiidae). *Archives (Nouvelle Série) de l'Institut Grand-Ducal de Luxembourg, Section des Sciences Naturelles, Physiques et Mathématiques* 32: 267-271.
- Thorn, R. 1966b. Observations sur l'accouplement chez le Chioglosse portugais (*Chioglossa lusitanica* Bocage, 1864, Salamandridae). *Archives (Nouvelle Série) de l'Institut Grand-Ducal de Luxembourg, Section des Sciences Naturelles, Physiques et Mathématiques* 31: 165-167.
- Thorn, R. 1972. Ethologie sexuelle et reproduction en captivité de l'*Hynobius naevius* (Temminck et Schlegel 1838) (Amphibia, Caudata, Hynobiidae). *Archives (Nouvelle Série) de l'Institut Grand-Ducal de Luxembourg, Section des Sciences Naturelles, Physiques et Mathématiques* 35: 129-133.
- Thorn, R. 1986. Propos sur le comportement sexuel et sur la reproduction en captivité chez quatre espèces de Salamandres de la famille des Hynobiides

- (Amphibia, Caudata). Bulletin, Societe des Naturalistes Luxembourgeois 86: 67-74.
- Thorn, R. 1987. Comportement sexuel, ponte et fécondation chez la Salamandre du Semiretchensk *Ranodon sibiricus* Kessler. Archives (Nouvelle Série) de l'Institut Grand-Ducal de Luxembourg, Section des Sciences Naturelles, Physiques et Mathématiques 40: 97-101.
- Thorn, R. 1994. Courtship behavior, fertilization of eggs, and rearing in captivity of the Semirechensk Salamander, *Ranodon sibiricus* Kessler (Amphibia Caudata). Russian Journal of Herpetology 1 (1): 86-90.
- Usuda, H. 1993. Reproductive behavior of *Hynobius nigrescens*, with special reference to male midwife behavior. Japanese Journal of Herpetology 15: 64-70.
- Usuda, H. 1997. Individual relationship of male aggressive behavior during the reproductive season of *Hynobius nigrescens*. Japanese Journal of Herpetology 17: 53-61.
- Uzzell, T.M., Jr. 1964. Relations of the diploid and triploid species of the *Ambystoma jeffersonianum* complex (Amphibia, Caudata). Copeia 1964: 257-300.
- Verrell, P. 1982. The sexual behaviour of the red-spotted newt, *Notophthalmus viridescens* (Amphibia: Urodela: Salamandridae). Animal Behaviour 30: 1224-1236.
- Verrell, P.A. 1994a. The courtship behaviour of the Apalachicola dusky salamander, *Desmognathus apalachicola* Means & Karlin (Amphibia: Caudata: Plethodontidae). Ethology Ecology Evolution 6: 497-506.
- Verrell, P.A. 1994b. Courtship of the salamander *Desmognathus imitator* (Amphibia: Caudata: Plethodontidae). Amphibia-Reptilia 15: 135-142.
- Verrell, P.A. 1995. The courtship of the spotted dusky salamander, *Desmognathus fuscus conanti* (Amphibia: Caudata: Plethodontidae). Journal of Zoology, London 235: 515-523.
- Verrell, P.A. 1997. Courtship in desmognathine salamanders: the southern dusky salamander, *Desmognathus auriculatus*. Journal of Herpetology 31: 273-277.
- Verrell, P.A. 1999. Bracketing the extremes: courtship in the smallest- and largest-bodied species in the salamander genus *Desmognathus* (Plethodontidae: Desmognathinae). Journal of Zoology, London 247: 105-111.
- Verrell, P.A. and Krenz, J. 1998. Competition for mates in the mole salamander, *Ambystoma talpoideum*: tactics that may maximize male mating success. Behaviour 135: 121-138.
- Verrell, P. and Mabry, M. 2000. The courtship of plethodontid salamanders: form, function, and phylogeny. Pp. 371-380. In R. C. Bruce, R. G. Jaeger and L. D. Houck (eds), *The Biology of Plethodontid Salamanders*. Plenum Press, New York, NY.
- Verrell, P.A. and Pelton, J. 1996. The sexual strategy of the central long-toed salamander, *Ambystoma macrodactylum columbianum*, in southeastern Washington. Journal of Zoology, London 240: 37-50.
- Whiteman, H.H., Wissinger, S.A. and Bohonak, A.J. 1994. Seasonal movement patterns in a subalpine population of the tiger salamander, *Ambystoma tigrinum nebulosum*. Canadian Journal of Zoology 72: 1780-1787.
- Wyman, R.L. 1971. The courtship behavior of the small-mouthed salamander, *Ambystoma texanum*. Herpetologica 27: 491-498.